

Newline

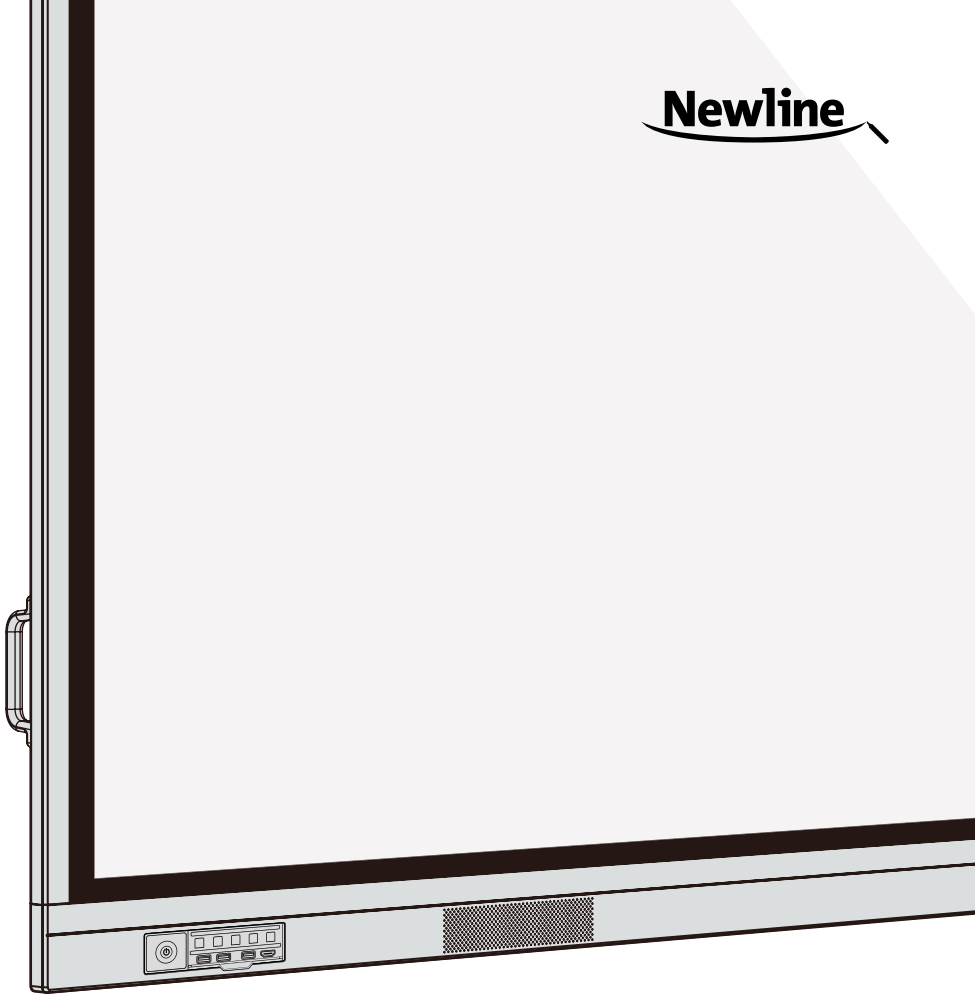

TRU TOUCH *VN Series*

Interactive Display

User Manual

-V1.0-

Contents

Safety Instruction	01
About This Document	04
A. Overview	05
Introduction	05
Parts	05
Ports	07
Remote Control	09
Temperature Control	11
B. Installation Guide	12
Safety Precautions	12
Installation Precautions	13
Installation	14
Installing the Internal PC (Optional)	15
Installing Newline Assistant	16
C. Getting Started	17
Power On	17
Power Off	18
Calibration	19
D. Operating the Interactive Display	22
Start Screen	22
Home	22
System Settings	27
Windows	39
Connection	40
Whiteboard	40
Add Shortcut	49
Gadget	52
File Management	53
End Meeting	56
E. Quick Setting Menu	59
F. Serial Port Control	60
G. FAQs & Troubleshooting	65
H. Specifications	68
I. More Information	71

Welcome to the world of TRUTOUCH.

Thank you for choosing the TRUTOUCH VN series interactive display. Please use this document to get the most out of your display.

This device complies with part 15 of the FCC Rules. Operation is subject to the following two conditions:(1) This device may not cause harmful interference, and (2) this device must accept any interference received, including interference that may cause undesired operation.

NOTE 1:This equipment has been tested and found to comply with the limits for a Class B digital device, pursuant to part 15 of the FCC Rules. These limits are designed to provide reasonable protection against harmful interference in a residential installation. This equipment generates, uses and can radiate radio frequency energy and, if not installed and used in accordance with the instructions, may cause harmful interference to radio communications. However, there is no guarantee that interference will not occur in a particular installation. If this equipment does cause harmful interference to radio or television reception, which can be determined by turning the equipment off and on, the user is encouraged to try to correct the interference by one or more of the following measures:

- Reorient or relocate the receiving antenna.
- Increase the separation between the equipment and receiver.
- Connect the equipment into an outlet on a circuit different from that to which the receiver is connected.
- Consult the dealer or an experienced radio/TV technician for help.



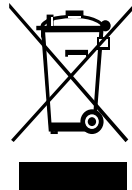

NOTE 2: Any changes or modifications to this unit not expressly approved by the party responsible for compliance could void the user's authority to operate the equipment.

The symbol of the crossed out wheeled bin indicates this product should not be placed in municipal waste. Instead, dispose of waste equipment by taking it to a designated collection point for electrical and electronic equipment recycling.



Safety Instruction

For your safety, please read the following instruction before you use the product. Serious injury or property damage may be caused by improper operations. Do not try to repair the product on your own.

 WARNING	
	<p>Disconnect the product from power supply immediately if major failures occur.</p> <p>Major failures include the following:</p> <ul style="list-style-type: none"> • Smoke, peculiar smell or abnormal sound is discharged from the product. • No image or sound is displayed, or the image error occurs. <p>In the preceding scenarios, do not continue to use the product. Disconnect power supply immediately and contact professional staff for troubleshooting.</p>
	<p>Do not drop liquid, metal or anything combustible into the product.</p> <ul style="list-style-type: none"> • If any liquid or metal is dropped into the product, power off the product and disconnect power supply, then contact professional staff for solutions. • Pay attention to children when they are close to the product.
	<p>Put the product on a stable surface.</p> <p>An unstable surface includes and is not limited to an inclined plane, a shaky stand, desk or platform, which might cause turnover and damage.</p>
	<p>Do not open the cover or change the product on your own.</p> <p>High voltage components are installed in the product. When you open the cover, high voltage, electric shock, or other dangerous situations may occur. If inspection, adjustment, or maintenance is required, contact the local distributor for help.</p>
	<p>Use the specified power supply.</p> <ul style="list-style-type: none"> • To prevent the product from being damaged, do not use any cables other than the one provided with the product. • Use a three-wire socket and ensure that it is properly grounded. • Pull out the power plug from the socket if the product is not used for a long period.
	<p>Clean the dust and metal on the power plug regularly.</p> <ul style="list-style-type: none"> • Fire or electric shock may be caused if the product is powered on, when you are cleaning. • Pull out the power plug before cleaning it with a dried cloth.
	<p>The voltage/current of the rear power output port is 5 V/2 A (maximum). Purchase the power code/AC adapter according to customer needs. The port can be used for Newline Android box X10D. Please do not connect any products with different power requirement. Otherwise, it may cause damage to products or fire.</p>

WARNING



Do not put items on the top of the product.

- Do not put items, such as a container for liquid (a vase, flowerpot, cosmetics or liquid medicine) on the top of the product.
- If any water or liquid is spilled on the product, a short circuit may occur and cause fire or electric shock.
- Do not walk on or hang any items on the product.



Do not install the product in an improper place.

- Do not install the product in humid places, such as the bathroom, the shower room, near windows, or outdoor environments that experience rain, snow or other harsh weather. Avoid installation near hot spring vapor. The preceding environments may cause faults in the product or electric shock under extreme conditions.
- Do not put exposed fire source, such as an ignited candle, on the product.



Pull out the power plug during thunderstorms.

- Do not touch the product during a lightning storm to avoid electric shock.
- Install or place components that supply high enough voltage to cause personal injury out of the reach of children.



Do not touch the power cable with wet hands.

CAUTION



Do not install the product in high temperature environments.

- Do not install the product near a heat source, such as a radiator, a heat reservoir, a stove or other heating products.
- Do not expose the product to direct sunlight, which may cause high temperatures and subsequent faults in the product.



For transport.

- Pack the product for transport or maintenance by using the cartons and cushioning material provided with the product.
- Vertically move the product during transport. The display or other components are easily broken if the product is moved by an improper way.
- Before you move the product, disconnect all external connections and separate all toppling preventing products. Move the product carefully to prevent it from being hit or squeezed, especially the screen, which may cause injury if broken.



Do not cover or block up any vents on the product.

- Any overheated components may cause fire, damage the product, and shorten the service life.
- Do not lay the product down where the venting surface will be covered.

CAUTION



- Do not install the product on a carpet or cloth.
- Do not use a cloth such as table cloth to cover the product.



Use the battery correctly.

- Galvanic corrosion, electric leakage, and even fire may be caused by improper battery usage.
- It is recommended to use the designated type of battery and install the battery by correct electrodes (positive and negative).
- Do not install and use a new battery with a used one.
- Take out the batteries if the remote control is not used for a long period.
- Do not expose the batteries to overheated environments such as sunlight and firing.
- Dispose of the used batteries based on your local regulations.

Do not damage the power cable.

- Do not damage, change, twist, bend, or forcibly drag the power cable.
- Do not put weights (such as the product itself) on the power cable.
- Do not forcibly drag the cable when you pull out the power plug. If the power cable is damaged, please contact the local distributor to repair or replace it.
- The power cable in the accessory box is for this product only. Do not use it on other products.

Additional advice:

- Use the product in an environment with comfortable lighting. It is harmful to your eyes to watch in a too bright or too dark environment.
- Relax your eyes after a period of time for watching.
- Keep sufficient distance from the product to protect your eyes and prevent eyestrain.
- Adjust the volume to an appropriate level, especially at night.
- Use amplifier equipment as the audio input source with caution. If you must use amplifier equipment, the input power should not exceed the maximum of speaker power. Otherwise, the speaker can become overpowered and damaged.

About USB port.

Front USB 2.0 ports and rear USB 3.0/USB 2.0 ports switch connections based on signal sources. If the current signal source is reading the data from an external product connecting to the port, please switch the signal source after the data reading is complete. Otherwise, the data or product may be damaged.

Keep away from the product when you use a radio.





The product complies with the international EMI standard to prevent radio interference. However, interference may still exist and causes noise in the radio. If noise occurs in the radio, try the following solutions.

- Adjust the direction of the radio antenna to avoid the interference from the product.
- Keep the radio away from the product.

About This Document

.....

This document describes multiple functions, instructions, and notes about the product. Symbols are used in this document to indicate operations that need particular attention. The symbols are defined as follows:

 NOTE	Provides additional information to supplement operation in the main text.
 TIP	Provides tips for operation.
 CAUTION	Indicates a potentially hazardous situation that, if not avoided, could result in equipment damage, data loss, performance deterioration, or unanticipated results.
 WARNING	Indicates a hazard with risk that, if not avoided, could result in death or injury.

A

Overview

Introduction

The Interactive Touch display adopts the advanced touch technology and All in One design, and integrates video, audio, touch, writing, and multi-media presentation functions. This product does not require additional products, installation and wiring, and commissioning and maintenance to function.

Dedicated smart system is customized as a meeting assistant. It can meet requirements of various meeting modes, implementing convenient comments on local documents, viewing multi-media files, conducting multi-party remote video and audio meetings, managing local files, and improving the meeting experience and work efficiency.

- All-in-one design facilitates operation and saves complex hardware and software setting.
- 4K HD LED screen uses full lamination technology and high gamut backlight, which completely avoids light refraction and ghosting problems and enables a clear, light and thin screen.
- Provide perfect writing experience, enable writing mode to be switched over in the Windows and smart systems, and automatically identify pen thickness and color. With a feel like writing on paper, meeting quality is significantly improved.

Parts

Front View

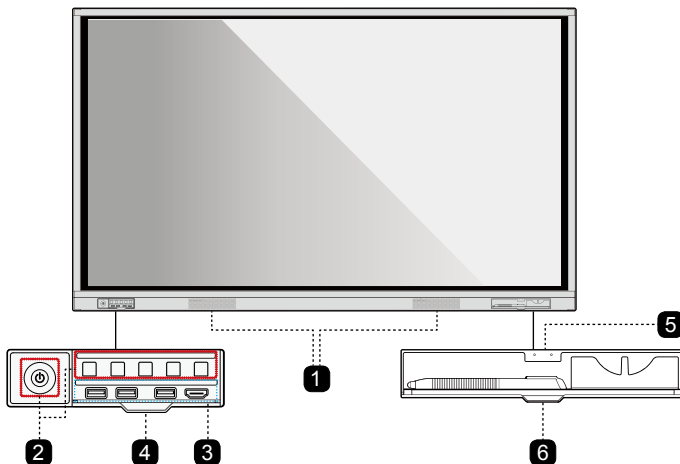

Rear View

- TT-8618VN/TT-7518VN

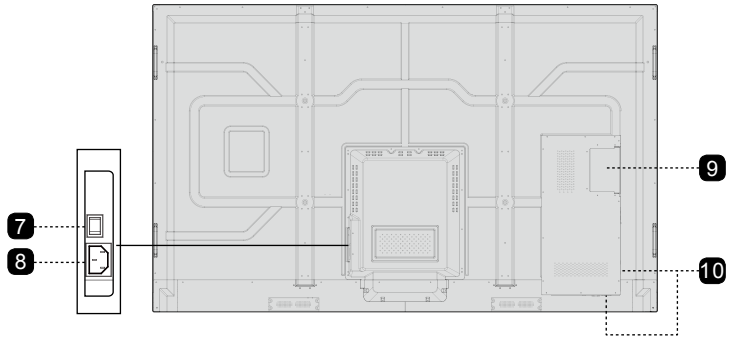

- TT-6518VN

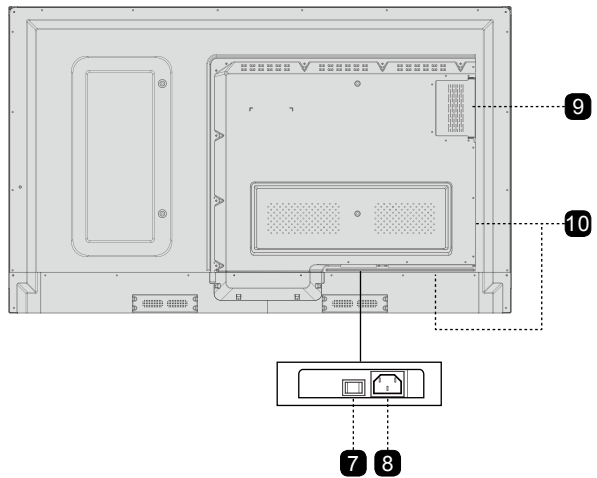

- | | |
|---------------------------------|--------------------------------|
| 1 Speakers | 2 Front Buttons |
| 3 Front Ports | 4 Button Cover |
| 5 Pen/Eraser Tray | 6 Pen/Eraser Tray Cover |
| 7 Power Switch | 8 Power Supply Plug |
| 9 Internal PC Port (OPS) | 10 Rear Ports |

Ports

Front Ports

CAUTION

Front USB 2.0 ports and rear USB 3.0/USB 2.0 ports switch connections based on signal sources. If the current signal source is reading the data from an external product connecting to the port, please switch the signal source after the data reading is complete. Otherwise, the data or product may be damaged.

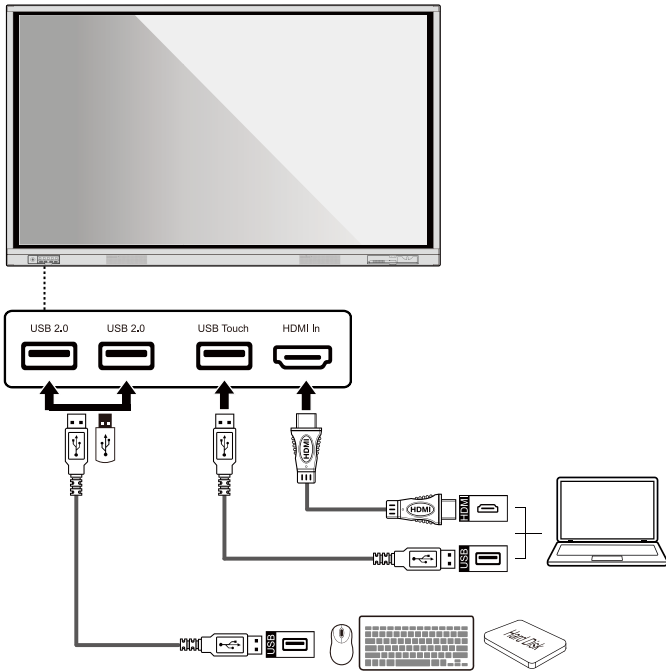

Rear Ports

WARNING

The voltage/current of the rear power output port is 5V/2A (maximum). Purchase the power code/AC adapter according to customer needs. The port can be used for Newline Android box X10D. Please do not connect any products with different power requirement. Otherwise it may cause the damage to products or fire.

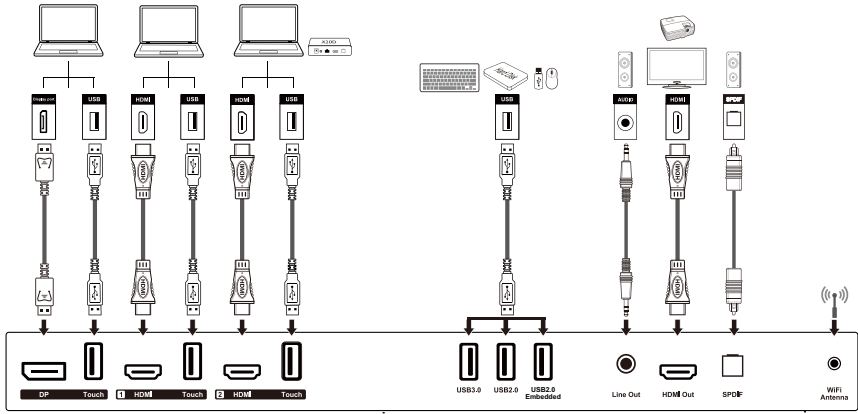

• TT-8618VN/TT-7518VN

• TT-6518VN

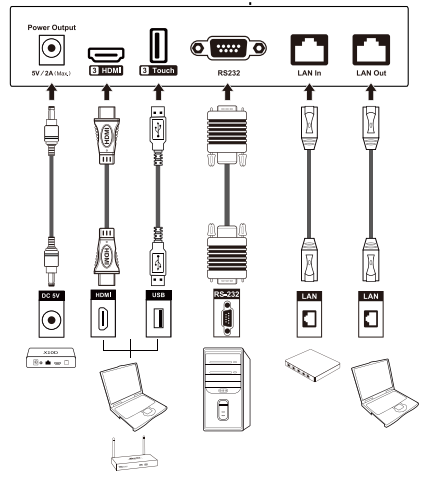
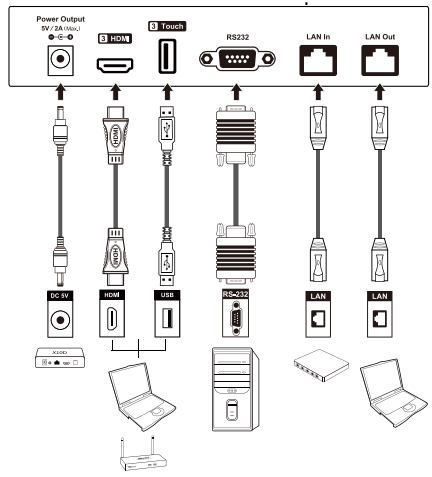
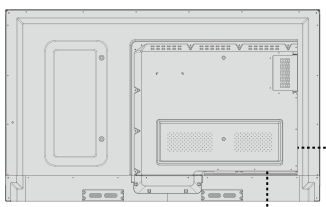
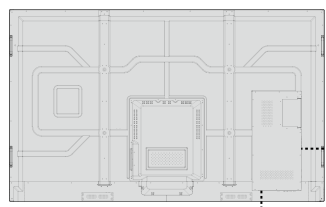

Tip:
You are advised to connect X10D to HDMI rear 2.

Front Buttons

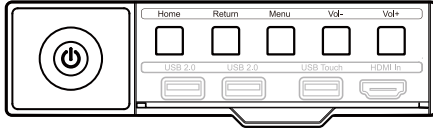

Buttons	Operations	Functions
Power	Short press	Power on/off Indicator LED status: <ul style="list-style-type: none"> • Steady on red: shut down mode • Steady on green: working state
Home	Short press	Go to the home page
Return	Short press	Return to the last menu/Exit
Menu	Short press	Open the menu
Vol-	Short press	Decrease the sound volume
	Long press for more than 1 second	Decrease the sound volume continuously
Vol+	Short press	Increase the sound volume
	Long press for more than 1 second	Increase the sound volume continuously















Remote Control



CAUTION

Carefully read the following instructions before using the remote control to avoid possible faults:

- Do not drop or damage the remote control.
- Do not spill water or other liquids on the remote control.
- Do not place the remote control on a wet object.
- Do not place the remote control directly under sunlight or near an overheating heat source.

Buttons	Functions
	Power On/Off.
PC	Switch Source to Internal PC.
	Mute/Unmute Audio.
	Freeze the Current Screen, Click Again to Exit Freeze Function.
OK	Confirm/OK.
	Up/Down/Left/Right.
	Return to Previous/Exit.
	<ul style="list-style-type: none"> • Short Press: Go to the Home Page. • Long Press: View Currently Running Applications.
	Take a Screenshot.
	Decrease the Sound Volume.
	Increase the Sound Volume.
	Open the System Settings.
	Page Up.
	Page Down.
	Zoom In.
	Zoom Out.
Front	Switch Source to HDMI Front.
Rear 1	Switch Source to HDMI Rear 1.
Rear 2	Switch Source to HDMI Rear 2.

Buttons	Functions
Rear 3	Switch Source to HDMI Rear 3.
	Toggle Display Backlight Mode (including Auto, Standard and EnergyStar mode).
DP	Switch Source to DisplayPort.
Menu	Open the Display Menu or External Source Menu.



Temperature Control

In certain special installation or operation environments, the ventilation condition of the screen is poor and the heat dissipation efficiency is low. As a result, the internal temperature can rise. When the internal temperature sensor detects that the temperature has reached the threshold, the system will go to shut down mode to avoid any permanent damages to the components caused by high temperature. Please check the device and environment, and turn the power on again.

B

Installation Guide

Safety Precautions

Installation Environment



Avoid Electric Shock



Avoid Strong Magnetic Field



Keep Temperature Below 120° F ($\leq 50^{\circ}\text{C}$)



Keep Relative Humidity Under 70%



Keep Away From Combustible Vapors (gas leaks, etc.)



Avoid Any Corrosive Liquids



Do Not Use Outdoors

Installation Direction

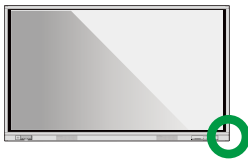

Hang the Product Horizontally



No Vertical Installation

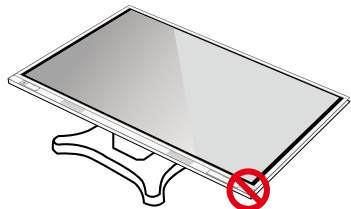

Do Not Lay Flat

Installation Precautions

Weight Loading

Weight of the product: 87.1 lb/39.5 kg (TT-6518VN), 111.3 lb/50.5 kg (TT-7518VN), 143.3 lb/65 kg (TT-8618VN)

- When using a mobile stand, please ensure the weight of the product is less than the loading capacity of the mobile stand.
- When using the wall-mount bracket, please ensure the wall can support the weight of the product. We recommend that the wall surface be reinforced and have a loading capacity 4 times of the weight of the product. Please consult a professional installer for wall-mount installation.

Note

The company does not undertake relevant legal responsibility for any problem caused by improper operation, if the third party mobile stand, or wall-mount bracket is beyond the scope of the product.

- Do not install the product where it might be hit by a door.

Ventilation

Ensure adequate ventilation and/or air conditioning environment. We recommend keeping certain distances from the side of the product to the wall or panels. Ventilation requirement is shown in following figure.

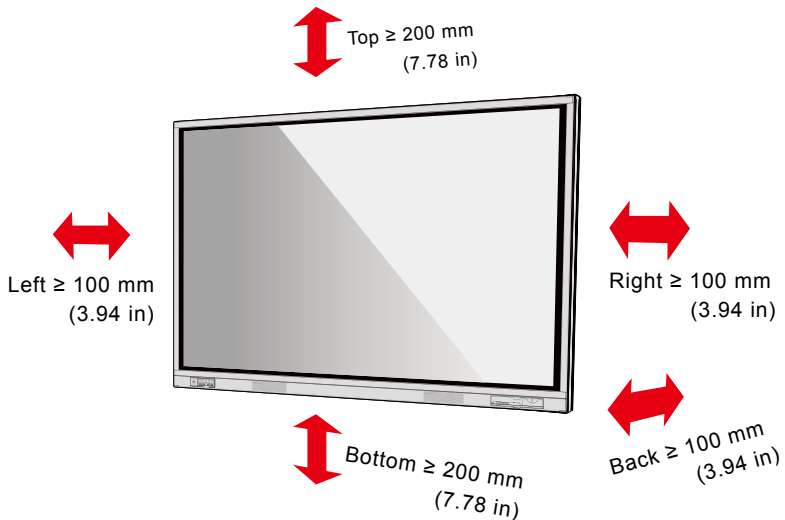

Installation

The dimensions of the 4 bracket mounting holes on the back panel are VESA MIS-Fcompliant (TT-8618VN or TT-7518VN: 800 x 400 mm/31.50 x 15.75 in; TT-6518VN: 600 x 400 mm/23.62 x 15.75 in). Please use metric M8 screws with length of 10 to 15 mm (0.40 to 0.59 in) to secure the touch display with the mounting system. Dimensions of the mounting holes on the back panel are shown in the following figure.

Note

Consult a professional installer to install the display product.

- TT-8618VN/TT-7518VN

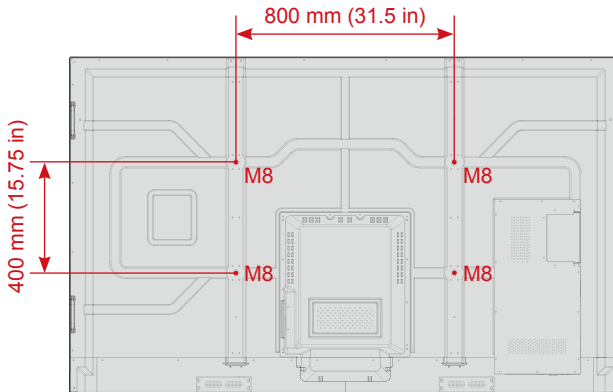

- TT-6518VN

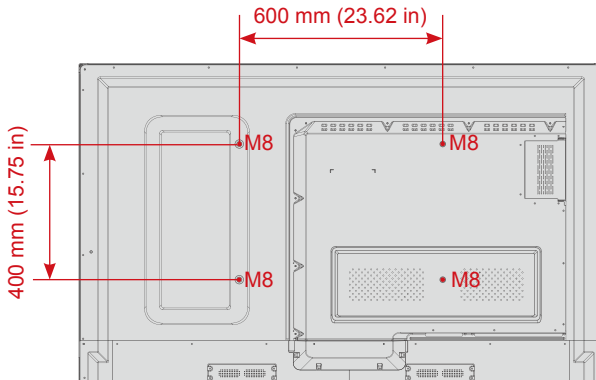

Installing the Internal PC (Optional)



CAUTION

The internal PC does not support hot plugging. Therefore, you must insert or remove it when the display is powered off. Otherwise, the display or internal PC may be damaged.

The internal PC is not configured by default. You need to purchase the internal PC separately. Perform the following steps to install the internal PC.

You will need to purchase the internal PC separately. Perform the following steps to install the internal PC.

Step 1: Unscrew the M3 screws by hand to remove the internal PC shielding cover.

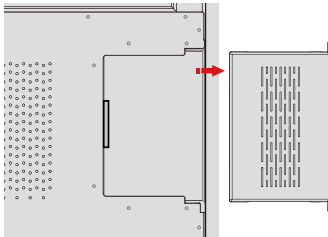

Step 2: Push the internal PC into the internal PC port at the rear of the display from right to left.

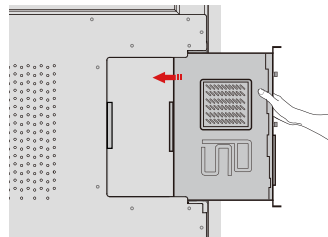

Step 3: Secure the internal PC to the display by using the M3 screws.

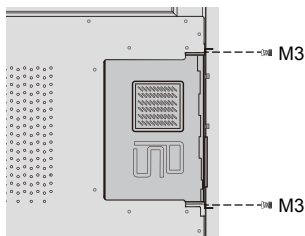

Step 4: Ensure the installation is correct before turning the power on again.

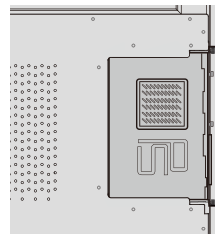

Installing Newline Assistant

Introduction

Newline Assistant is the tool used as a bridge between smart system and Internal PC (OPS). It helps to add windows software to smart system as well as to protect USB data/camera when switching between sources.

Therefore we strongly recommend users install Newline Assistant after installing the internal PC.

Installation

Step 1: Install Internal PC correctly.

Step 2: On the **Home** page, click **Windows**. It will switch the signal source to Internal Windows system.

Step 3: Log in to the website www.newline-interactive.com and choose **Products > Software** to download the Newline Assistant installation package.

Step 4: Install Newline Assistant as instructed.

C

Getting Started

Power On

Step 1: Plug the power supply into the power outlet fully and plug the power connector into the side of the product. Ensure the power is in the range of 100 V to 240 V with frequency at 50 Hz/60 Hz \pm 5%. The power current must be grounded.

 **Note**

The power outlet should be installed near the equipment and shall be easily accessible.

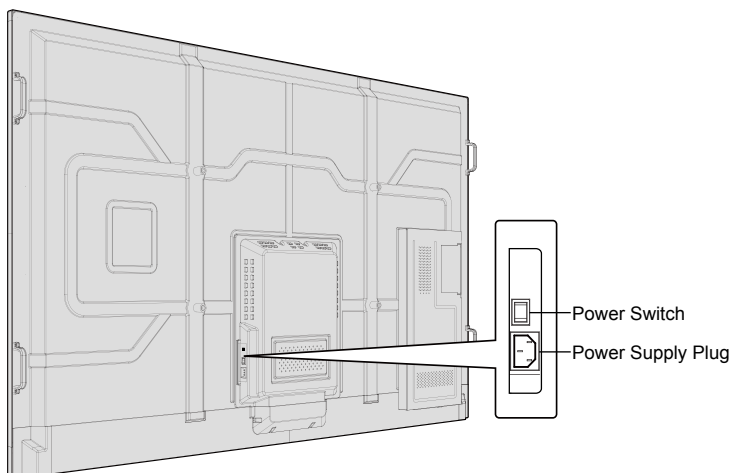

Step 2: Flip on the power switch located on the side of the product to “On”.

- TT-8618VN/TT-7518VN



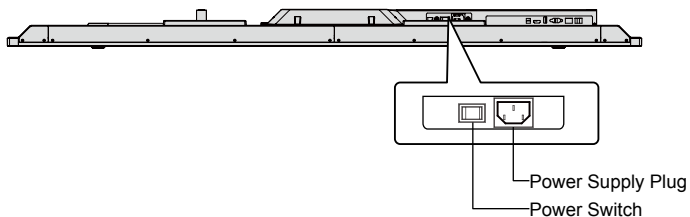

- TT-6518VN





Step 3: Press the power button  on the front control panel or  on the remote control.



Power Off

Step 1: Power off the screen in the following situations:

- If there is no whiteboard data or screenshot(s), press the power button  on the front panel or the power button  on the remote control to power off the screen. Go to Step 4.
- If there is whiteboard data or screenshot(s), store your meeting documentations before powering off the touch screen. Otherwise, the product will delete your meeting documentations after the meeting is complete.

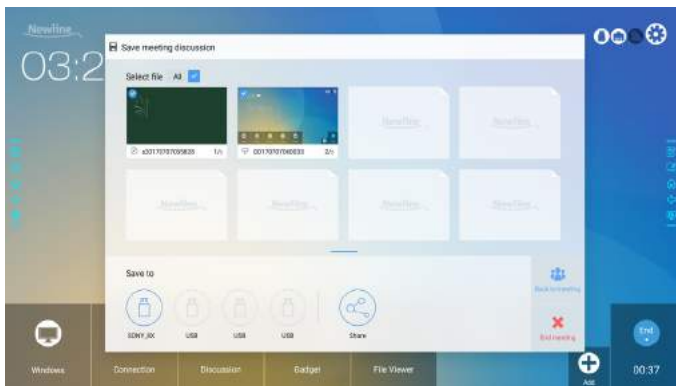
Press the power button  on the front panel or the power button  on the remote control. The **Save meeting discussion** page will be displayed as shown in the following figure.



Step 2: Press the power button  on the front panel or the power button  on the remote control again. The **Warning** dialog box will be displayed as shown in the following figure.

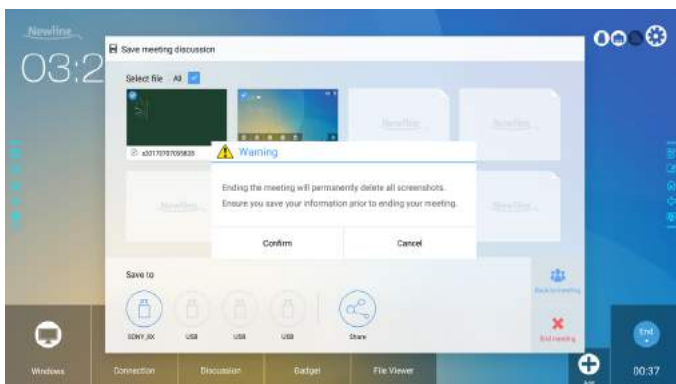

Step 3: In the **Warning** dialog box, click **Cancel**. You can save files if desired. After files are saved, return to Step 2. Click **Confirm**, and the power indicator will turn to red.

Step 4: If you are not going to use the product for an extended period of time, we recommend you to switch the power switch to “Off”.

 **Note**

- If an internal PC is equipped, the internal PC and the screen are powered off simultaneously when you power off the system.
- Do not forcibly disconnect the power supply of the screen when the internal PC is on.

Calibration

If the cursor position has a big deviation from the actual touch point, calibration is used to eliminate the deviation. Positioning is required in the following scenarios:

- The internal PC is used.
- A computer is connected through the HDMI or DisplayPort interface.

 **Note**

Interface operation on the Smart system does not need positioning. External products with Microsoft Windows 7 or later versions will require positioning.

If the positioning is not correct, perform the following operations to calibrate again. The following takes Windows 10 as an example:

Step 1: Ensure that the HDMI or DP interface and external products are connected properly.

Step 2: Select the corresponding Windows signal from the signal source menu. The Windows page will be displayed.

Step 3: Select **Tablet PC Settings** on the **Control Panel** page.

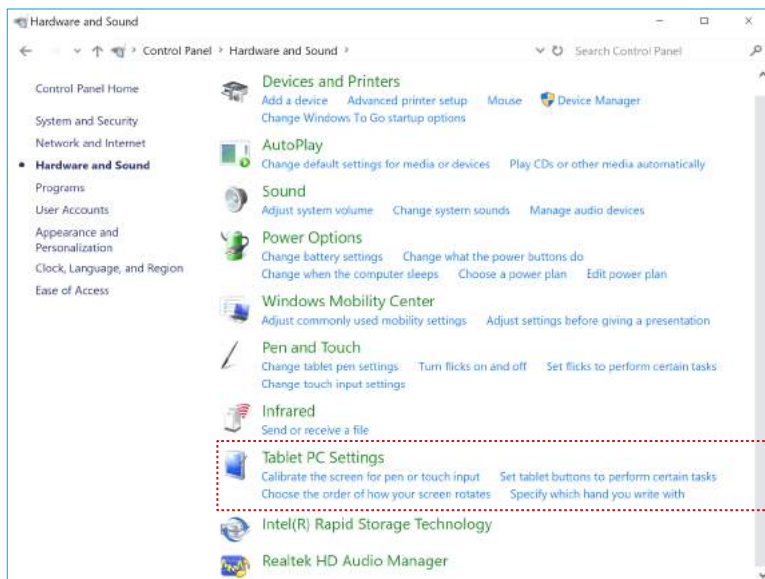

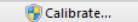
Step 4: Select  in the Tablet PC Settings window.

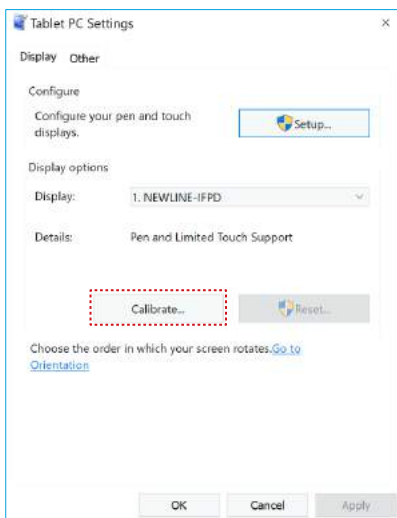

Step 5: Select **Touch input** from the option and start calibration.

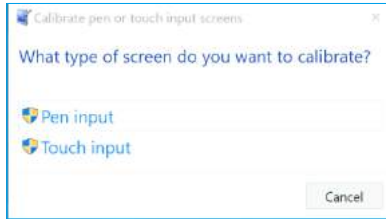

Step 6: Use finger or pencil to click and hold the center of the flickering cross + . Do not release it until + moves to the next positioning point. Complete the calibration process as instructed.

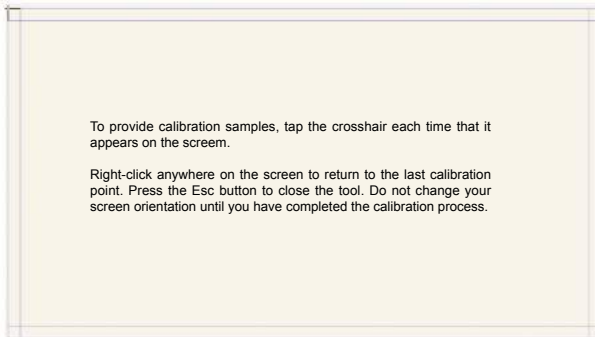

Step 7: After the calibration is complete, the **Digitizer Calibration Tool** dialog box will be displayed. Click **Yes** to save calibration data.

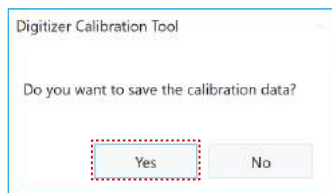

 **Tip:**

- To ensure writing accuracy, use the pencil or stylus included with the product for proper positioning.
- Positioning errors may cause failure of touch functions of the display. In that case, please perform positioning again.

Step 8: The **Tablet PC Settings** dialog box will be displayed again. Click **OK**. The positioning will be complete.

D Operating the Interactive Display

Start Screen

When the product is turned on, the product will show the start screen page. As shown in the following figure.



Home

Touch the screen to start a meeting, and the product will go to the **Home** page. As shown in the following figure.

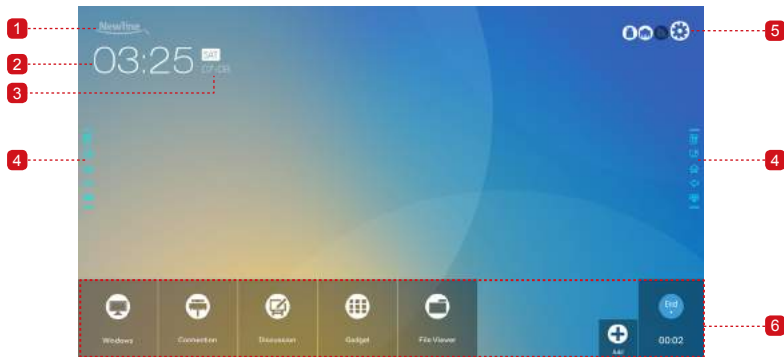

- 1 Logo (Shortcut to Settings)
- 2 Clock (Shortcut to World Clock)
- 3 Date and Week (Shortcut to Calendar)
- 4 Side Toolbar
- 5 Status Bar and Settings
- 6 Main Toolbar

Shortcut for Settings

Click the **Newline** icon on the **Home** page to enter the **logo & Wallpaper Setting** page to set the logo and wallpaper. The logo and wallpaper can be obtained locally or from a device connected via the USB port, as shown in the following figure.

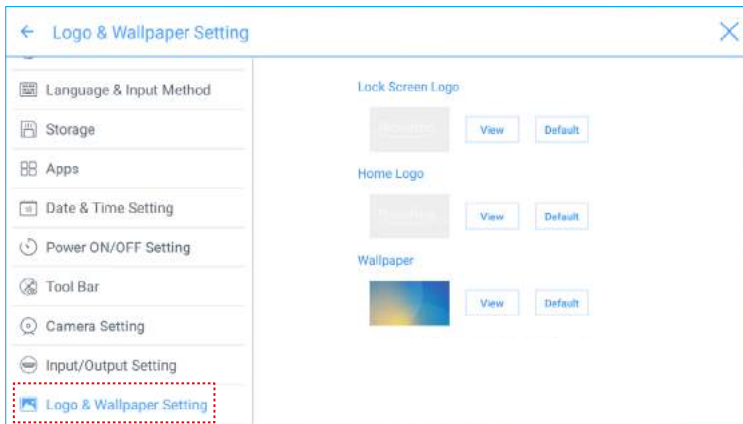

Shortcut for World Clock

Click the time icon on the **Home** page to enter the **Time Converter** page and convert the time and zone. Click **+** to add other time zones indicating other countries, as shown in the following figure.

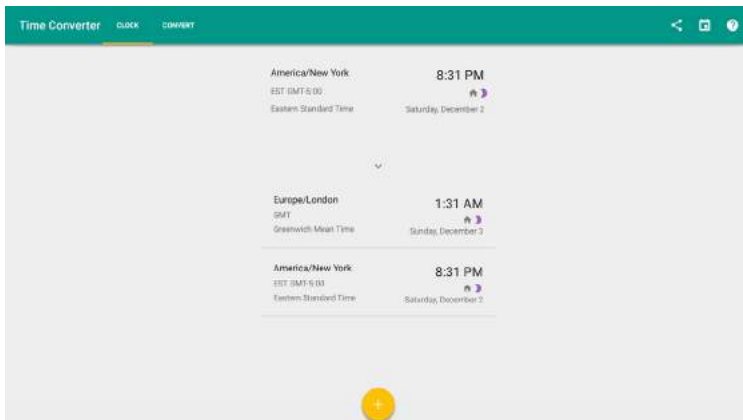

Shortcut for Calendar

Click this icon to enter the **Calendar** page and set schedules and synchronize with Google calendar, as shown in the following figure.

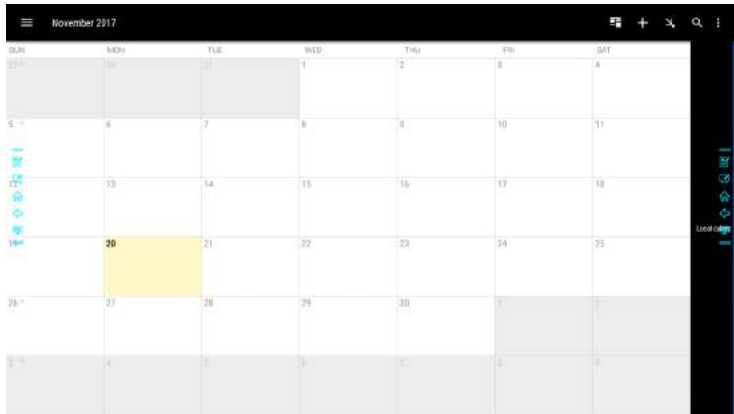





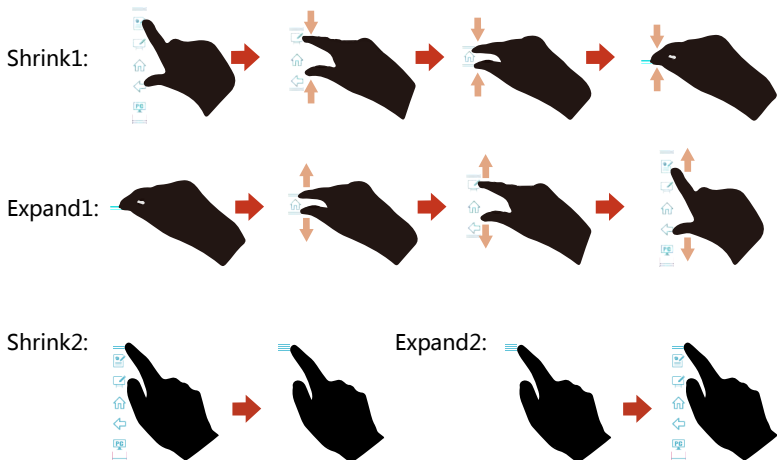



Side Toolbar

The Annotation Mode/Discussion Mode/Home/Return/Windows icons are displayed by default in the toolbar at two sides of the screen. The bottom side toolbar can be customized as your choice (The default icon is Windows). You may also hide the side tool bar at the setting or move it up and down, shrink or expand by gestures. You may double-click the \equiv to expand or shrink the toolbar. Long press the customized icon to unfold level-2 icons.







The functions of the side toolbar are as follows:







Icon	Functions
	Enter annotation mode, and click again to stop annotation and save screenshot.
	Enter discussion mode.
	Go to Home page.
	Return to the last menu/Exit.
	Enter the internal PC source.
	Manage currently running applications. Slide left/right the currently running application or click × at the upper right corner to close the application.
	Enter the favorite source.
	View all gadgets.

Status Bar and Settings

The upper right corner of the home page displays three working status icons (including USB flash memory(s), Ethernet, and Wi-Fi), and system setting shortcut.





Icon	Functions
	If USB flash memory(s) is connected to the USB port, this icon will be turned on. For details on the wiring method of the USB port, see section "Ports".
	If the product is connected to Ethernet, the icon will be turned on. For details on the wiring method of the wired network, see section "Ports".
	If the product is connected to a wireless network, the icon will be turned on. For details on the wiring method of the wireless network, see section "Ports".
	Access the system setting page.

Main Toolbars

Icon	Functions
	Switch to the internal PC source.
	Enter Connection to switch to the connected product, including cabled signal sources and wireless applications. <ul style="list-style-type: none"> • Cabled signal sources include HDMI Front, HDMI Rear (1 to 3), and DisplayPort. • Wireless applications include Montage and Trucast.
	Discussion provides discussion board function and screen annotation functions.
	Gadget displays all pre-installed applications, including Office viewer, Email, Calendar, Gallery, World clock, and Calculator . Click the icon of an application to run the application.
	Open the File Manager, and you can explore on internal and external files of the screen.
	Click Add to enter Add page, you can add up to 7 shortcuts to your favorite software, gadgets or connections to the Home page. (See more detail in “Add Shortcuts to Home Page”)
	Click End to end a meeting. Users will have the choice of saving the discussion boards screen captures and ending the meeting. Once a meeting is ended, all screenshots and discussion data are cleared.

System Settings

Enter the system setting page using one of the following methods:

- Click  or  on the **Home** page.
- Press  on the remote control.
- In the **Quick Setting Menu**, click the  icon.

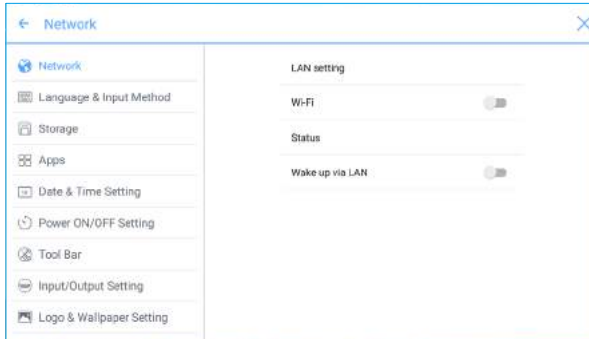

Network Settings

Enter the **Network** submenu to set a LAN, enable Wi-Fi, view network information, and enable the Wake up via LAN function.

- LAN setting: Automatically obtain the LAN IP address or set static IP address according to requirements.
- Wi-Fi: Click corresponding button to enable the Wi-Fi function.
- Status: View IP address, MAC address and work time of the display.
- Wake up via LAN: Click corresponding button to enable the Wake up via LAN function. Connect the display and PC to a same LAN using cables, run the Wake up via LAN, and search for the IP address and MAC address that match the display.

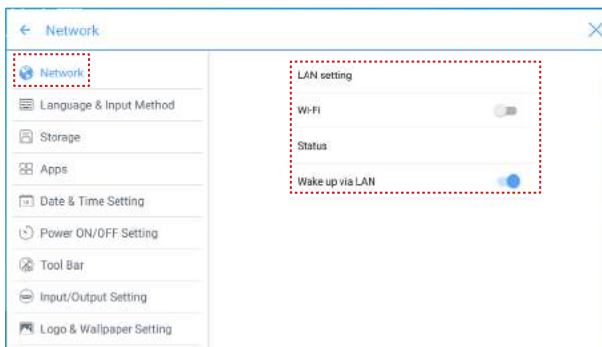

Language and Input Method Settings

Enter the **Language & Input Method** submenu to set language and input method.

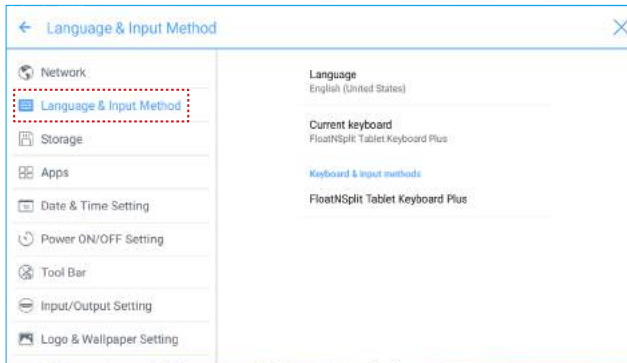



The default input method of the system is **FloatNSplit Table Keyboard Plus**, and **Hardware keyboard** must be enabled. If you want to switch to another language, switch the keyboard input method via **Keyboard & input methods**, in addition to switching the language.

Note

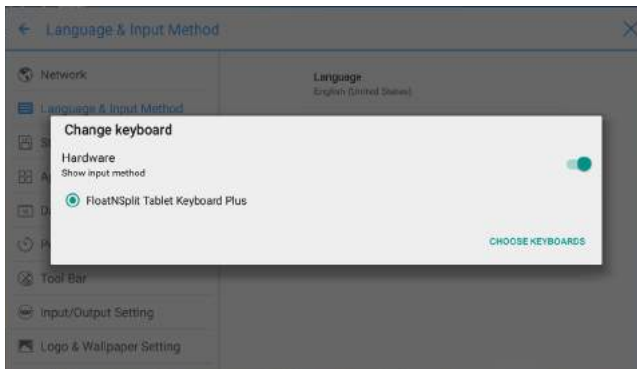
FloatNSplit Table Keyboard Plus does not support Chinese and Japanese.



FloatNSplit Table Keyboard Plus description:

-  : Drag this icon and change the size of the keyboard.
-  : Drag this icon to move the keyboard.
-  : Click this icon to switch the keyboard unfold mode.



Setting a Language

Click **Language** at the right side. In the **Change language** dialog box that is displayed, select a language.

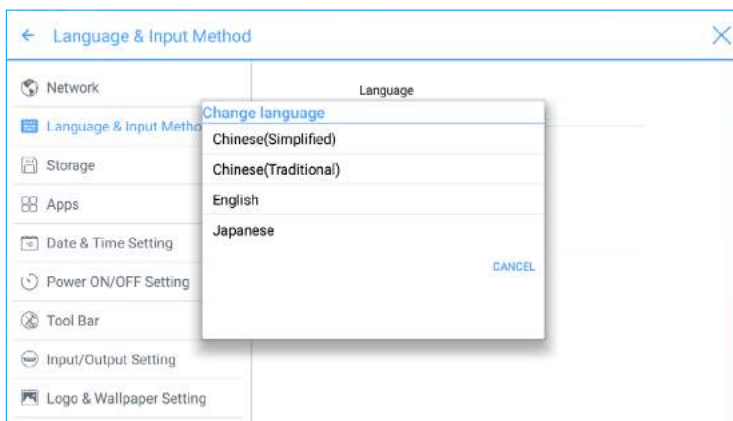

Adding an Input Method

Click **Current keyboard** at the right side. In the **Change keyboard** page, click **CHOOSE KEYBOARDS**, unfold **Keyboard & input methods**, and click the button at the right side according to reference to add an input method (multiple choices can be selected).

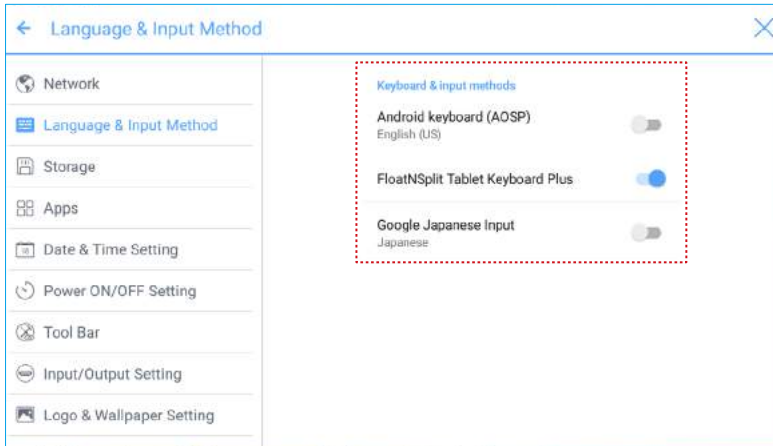

Setting an Input Method

Select an input method at the right side to set the attributes of the input method.

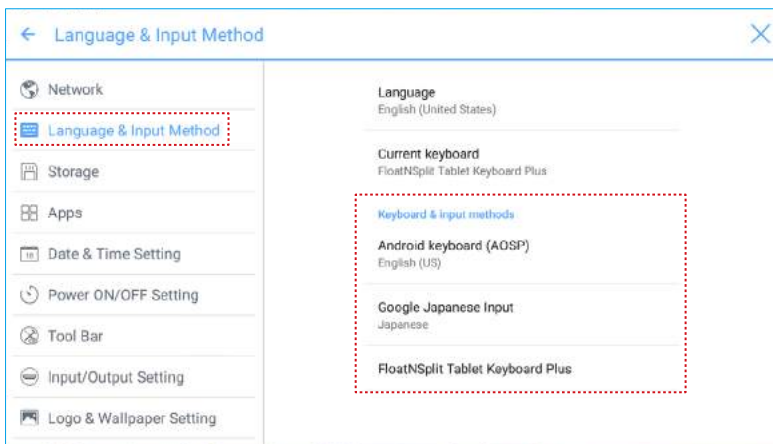

Storage

Enter the **Storage** submenu to view space distribution of the internal storage.

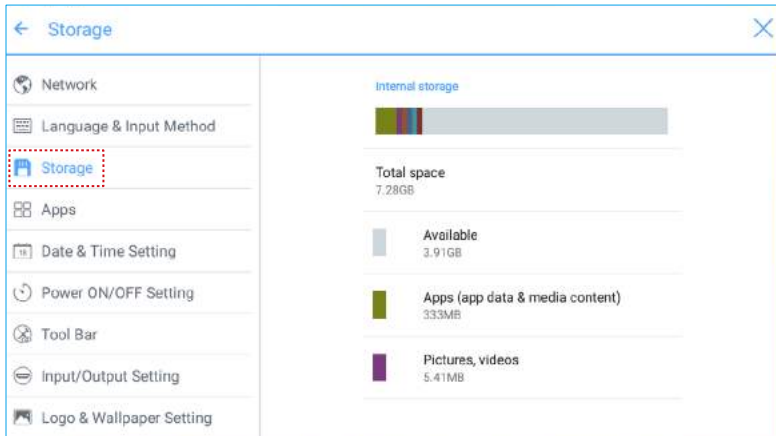

APPS

Enter the **Apps** submenu to view downloaded applications by type, running applications, and all applications.

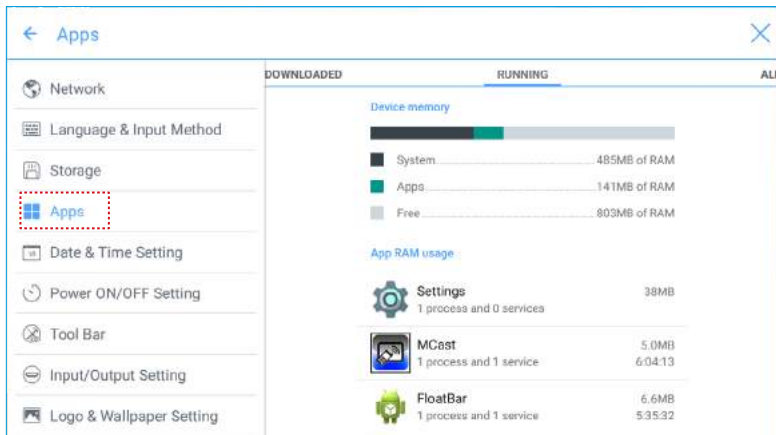

Date and Time Settings

Enter the **Date & Time Setting** submenu to set the date and time. Before setting the date and time, users should click **Select time zone** to select local time zone.

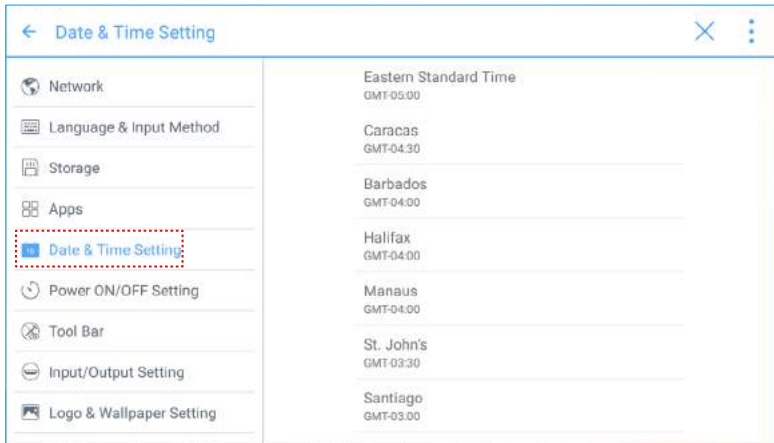

Setting a Date

You can automatically obtain the system date or customize a date.

- To automatically obtain a date, select **Automatic date & time**.

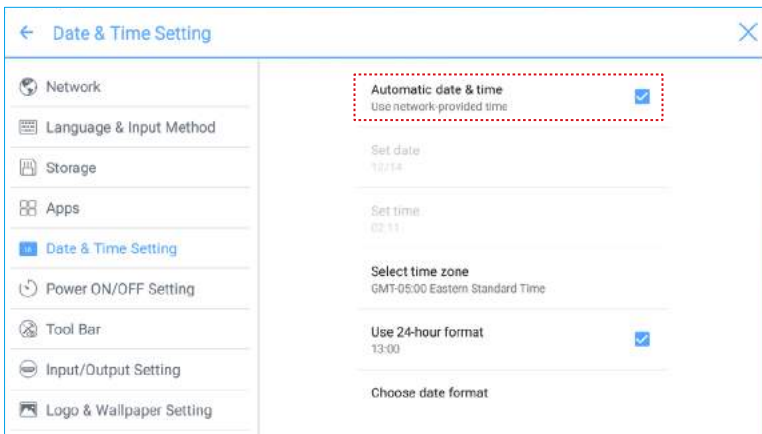

- To customize a date and date format, set them in **Set date** and **Choose date format**.

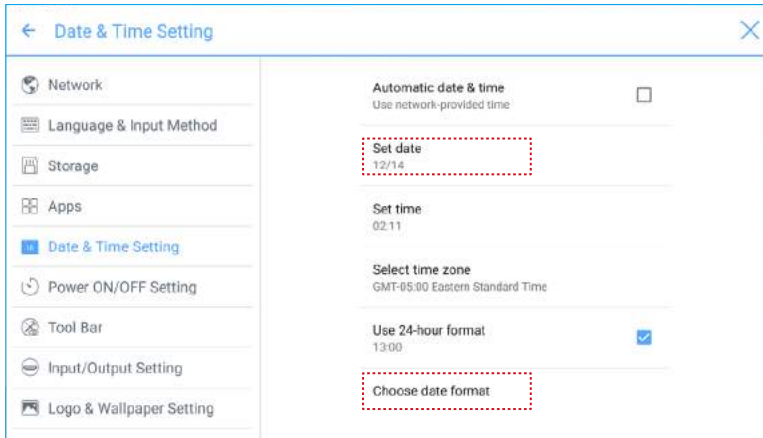

Setting Time

You can automatically obtain the system time or customize time.

- To automatically obtain time, select **Automatic date & time**.

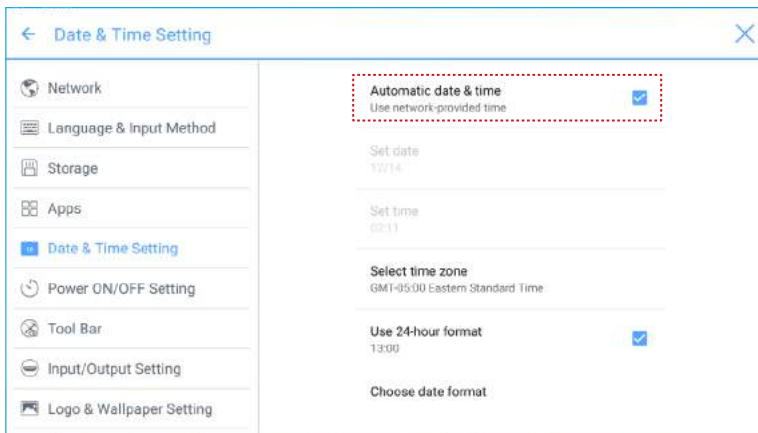

- To customize time and time format, set them in **Set time** and **Use 24-hour format**.

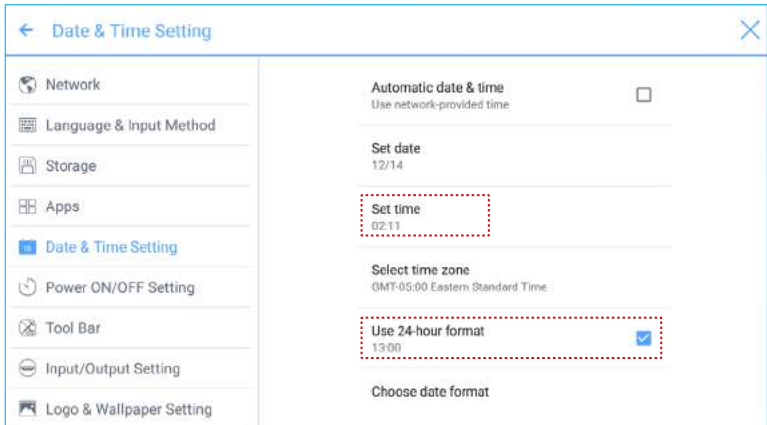

Power ON/OFF Setting

Enter the **Power ON/OFF Setting** submenu to set automatic power on/off time and the time for the system to enter the shut down mode.

- To set the automatic power on time, select **Auto power on**, and set the power on time in **Power on time**, as shown in the following figure.

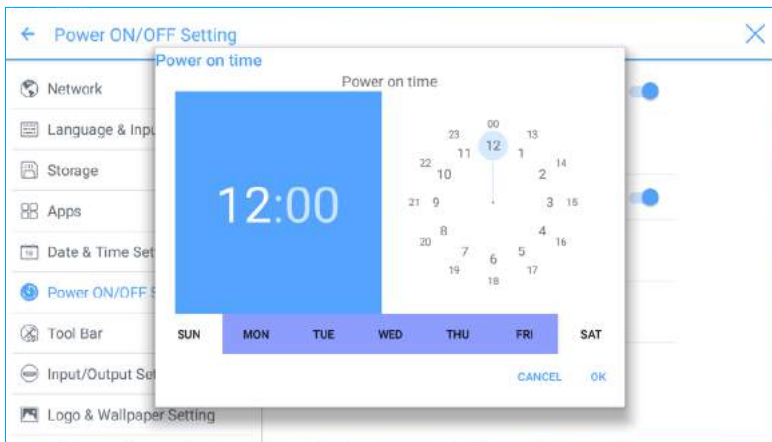

- To set the automatic power off time, select **Auto power off**, and set the power off time in **Power off time**, as shown in the following figure.

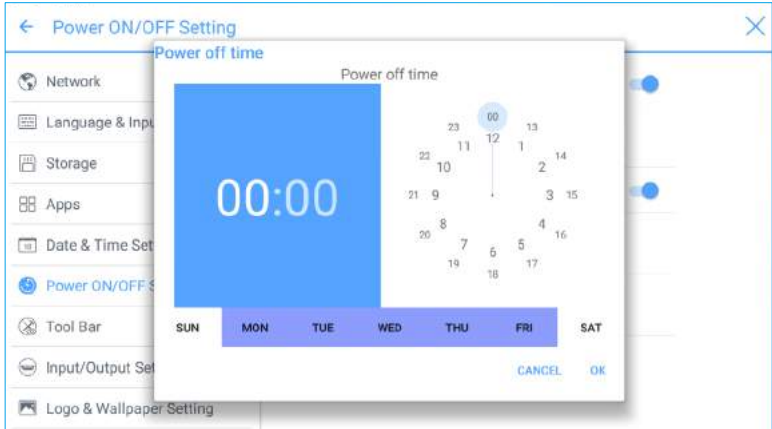

- To set the energy saving time, click **Energy saving**. In the dialog box that is displayed, set a duration after which the display enters the lock mode if the display is left un-operated. After the display is locked, if the user does not operate the display within 120s, the display enters the shut down mode. The duration can be set to **30 MIN**, **60 MIN**, **90 MIN**, or **NEVER**. You can also customize this duration and the range is 3 minutes to 480 minutes.



NEVER indicates that the automatic shut down mode function is not enabled.

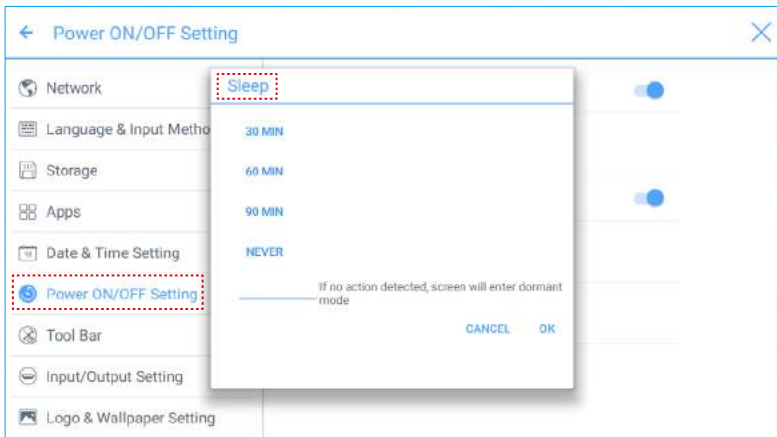

Tool Bar Setting

Enter the **Tool Bar** submenu to set whether to display the side tool bar and icons.

- Left: Click to turn on/off the left tool bar.
- Right: Click to turn on/off the right tool bar.
- Customized icon: Click the icon under **Customized icon** to display the last shortcut key at both sides of the tool bars. If you define the shortcut key as **Connection**, you can set a signal source to enter after this shortcut key is clicked in **Favorite Connection**.

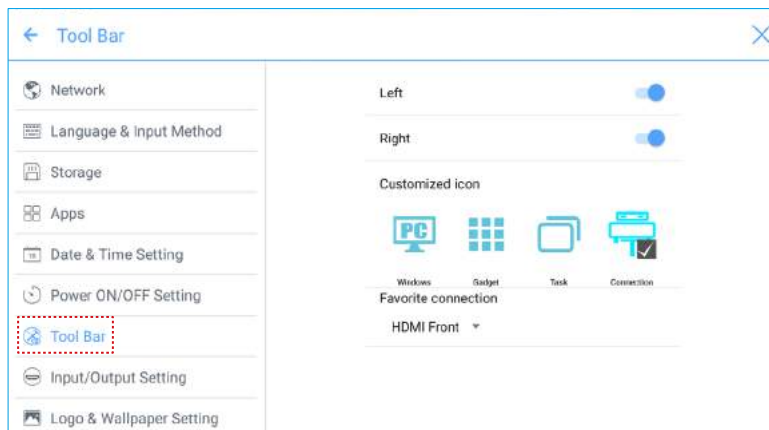

Input/Output Setting

Enter the **Input/Output Setting** submenu to set the automatic power on/off function of the consumer electronics control (CEC) device, new signal source, and resolution of image output through the HDMI port.

- After the **CEC auto power on** function is enabled and the display is connected with the CEC device via the HDMI port, the display automatically starts if the CEC device starts and the display receives a CEC startup command.
- After the **CEC auto power off** function is enabled and the display is connected with the CEC device via the HDMI port, the CEC device automatically stops if the display stops and the CEC device receives a CEC shutdown command.
- After the **New input source** function is enabled, the system can automatically switch to the screen of the newly connected signal source.

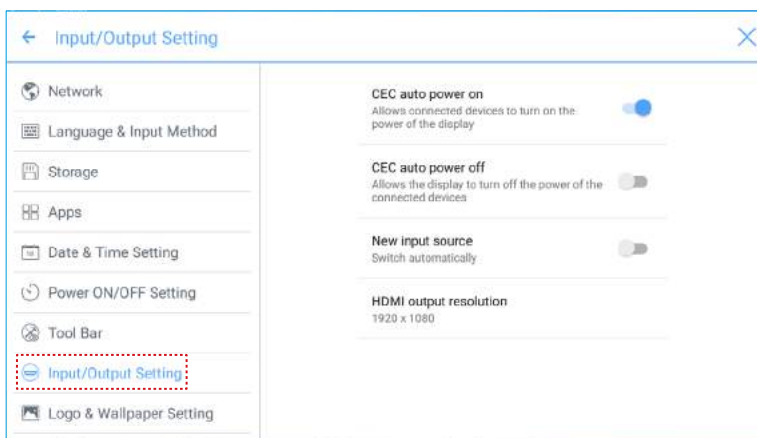

Logo and Wallpaper Setting

Enter the **Logo & Wallpaper Setting** submenu to set background, lock page, or Home page log.

On this page, click **View** to select a picture and automatically upload it to replace current picture. Click **Default**. The logo and wallpaper are reset to Newline pictures.

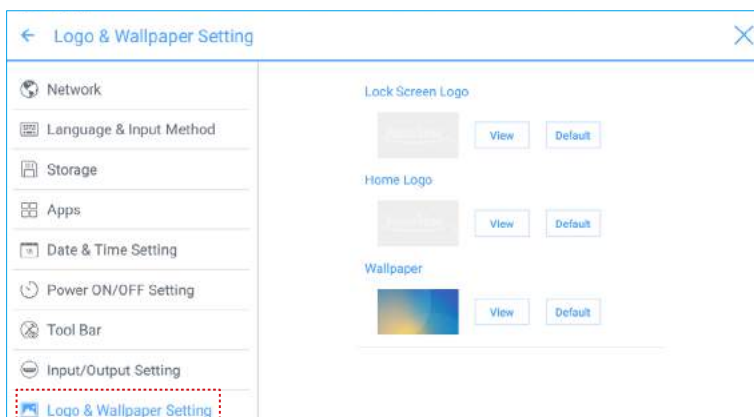

Smart Eye Protection

Enter the **Smart Eye Protection** submenu, according to the need to open the eye. The eye protection feature includes the image display effect, the display brightness of the white board at the time of writing, automatically changing the display brightness of the screen and filtering the blue light function according to the ambient brightness. The filter level can only be set if the Bluelight filter is enabled.

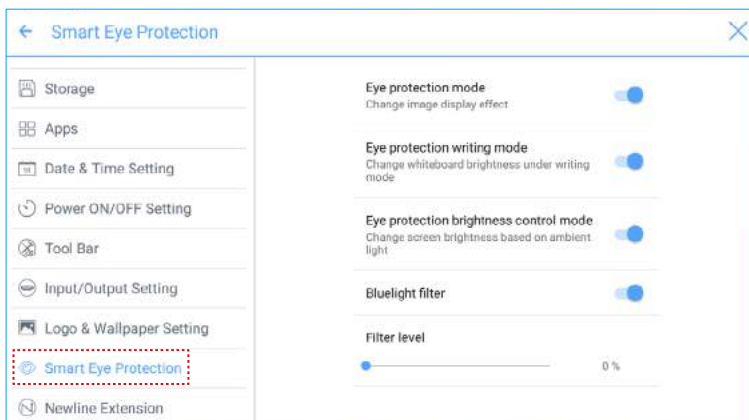

Newline Extension

Enter the **Newline Extension** submenu to set external devices (Trucast, X10D, and Trucam) to be displayed in the **Cable Connection** column of **Connection** and the wireless application Montage to be displayed in the **Wireless Connection** column. Furthermore, you can set the HDMI Rear channel to be displayed on the Trucast, X10D, or Trucam screen. If an auxiliary device of our company X10D is connected, the system identifies it through the CEC signal and automatically enables and switches to corresponding channel.

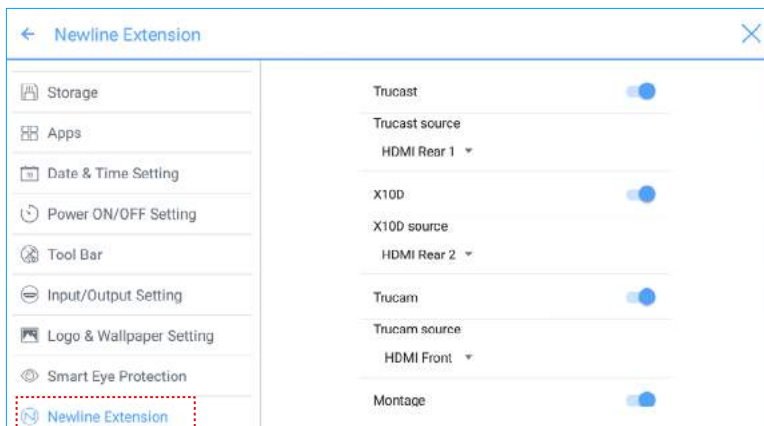

About

Enter the **About** submenu to view firmware or system version information, system upgrade, and factory setting.

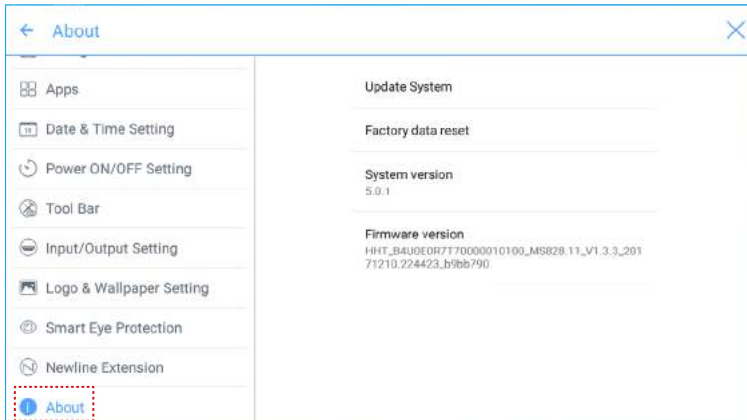

Windows

On the **Home** page, click **Windows** to enter the Internal PC source page, as shown in the following figure. If the screen is not equipped with an internal PC, "No Signal" is displayed.



Connection

On the Home page, click **Connection** to enter the connected product, including cabled signal sources and wireless applications.

- Cabled signal sources include HDMI Front, HDMI Rear (1 to 3), and DisplayPort.
You can preview the image of the corresponding signal channel. If the channel has no signal input, **No Signal** will appear. You can click the selected signal source to switch to the corresponding channel in full screen. You can also long press the signal source page and enter remark information in the **Modify remarks** dialog box that is displayed. If Trucast, Trucam, or X10D options have been enabled in **Newline Extension**, corresponding channel cannot be remarked.
- Wireless applications include Montage and Trucast.

Note

Montage should be installed manually to the internal PC first. If the Montage software is not added to the Newline assistant, the system prompts users to install Montage and add it into the Newline assistant. For details on the addition method, see section "Add Shortcuts to Home Page".



The first time you turn the display on, only the cable connections appear in **Connection**. Wireless connection can be added in the **Newline Extension** setting. In this case, the name and icon of the HDMI on the left cabled channel change as the Trucast application is enabled or an external product is connected. For details on the configuration, see section "Newline Extension". After the setting is successful, connect the Trucast, X10D and Trucam to corresponding HDMI ports of the display.

Whiteboard

The whiteboard has the following functions:

- **Discussion and screen annotation**

On the whiteboard page, you can select pen type, width, and color to write or annotate

on the screen. You can also erase selected content or clear all contents.



- **Page navigation**

Preview or delete pages.

Whiteboard Mode

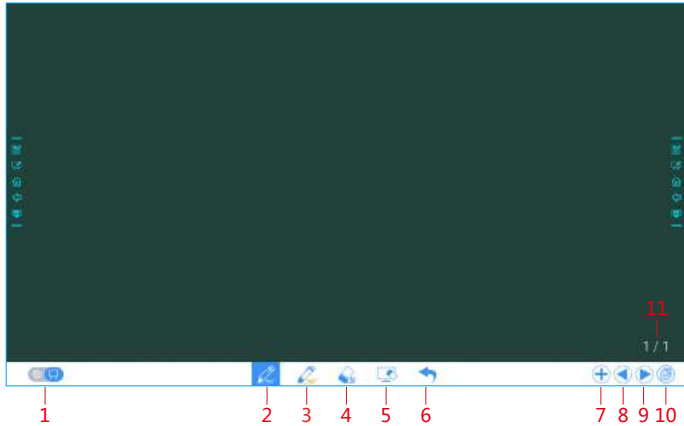
- Click **Discussion** in the main toolbar or click  in the side toolbar to enter the discussion mode, as shown in the following figure.



- Click  in the side toolbar or click  in the discussion mode to enter the annotation. In annotation mode it would generate a transparent layer above the screen, and user could add the annotation on it until they exit the annotation mode.

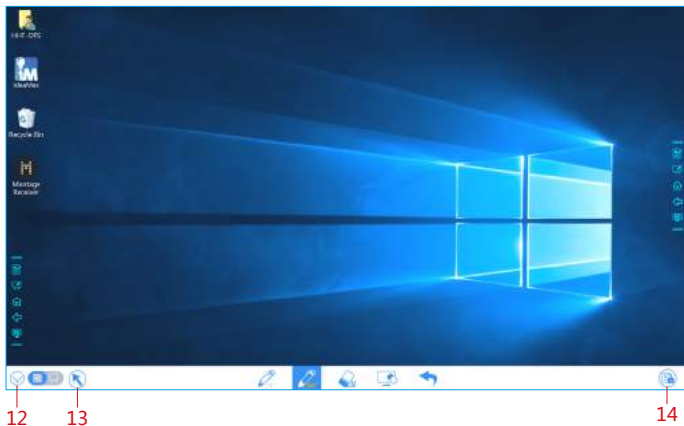

SN	Icon Name	Icon Function
1	Mode Switch	Click the icon to switch between annotation mode and the discussion mode. (See more detail in whiteboard mode section)
2	Pen	Click to use the pen function, and the icon turns into blue. Click and hold the icon for two seconds to set the size or color.
3	Highlighter	Click to use the highlighter function, and the icon turns into blue. Click and hold the icon for two seconds to set the size or color.
4	Eraser	Click to select the eraser function, when it is selected, the icon turns into blue. Click and hold the icon for two seconds to set the size of eraser.
5	Clear	Clear all data in this page.
6	Undo	Back to the previous step.
7	New Page	Click to add a new page. Click and hold for two seconds to set the color and the pattern of the new page.
8	Previous Page	Click to back to the previous page.
9	Next Page	Click to go to the next page.
10	Navigation	Click to show the page thumbnails.
11	Page Number	Shows which page is used right now.
12	Hide Smart Bar	Click to hide or show the smart bar.
13	Cursor	Click to use the cursor to control the Internal PC or external device. When the function be selected, the annotation part is still on the screen.
14	Screenshot	Click to print screen, and save the data in file management. Click and hold the icon for two seconds to show the pop-up windows to make users to choose if they want to save the screenshot automatically when they leave the annotation mode.

Whiteboard Functions

New Page and Settings

- Create a new page



In discussion mode, click  to create a new page. Up to 20 pages can be created. See the following figure.



- Page settings
Click and hold (+) for two seconds to set the color and the pattern of the new page, as show in the figure below.



Switch Whiteboard Mode

Click  and  in the lower left corner of the discussion mode to switch between whiteboard modes.

- : Annotation mode

The background is transparent and the real-time image of the current signal source will be displayed. You can comment on presentation content such as Office documents and pictures as showing in the following figure.





- : Discussion mode

The background is in mono color, as shown in the following figure. You can write content on the page as required.



Pen Type

On the Whiteboard, two types of pens are supported: Pen and highlighter.

- Pen : used to write.
- Highlighter : used to highlight. Characters covered by comments are visible.

Line Size and Color

On the Whiteboard, click and hold  or  for two seconds to set the size and color. You can select the line size and color for writing, as shown in the following figure.

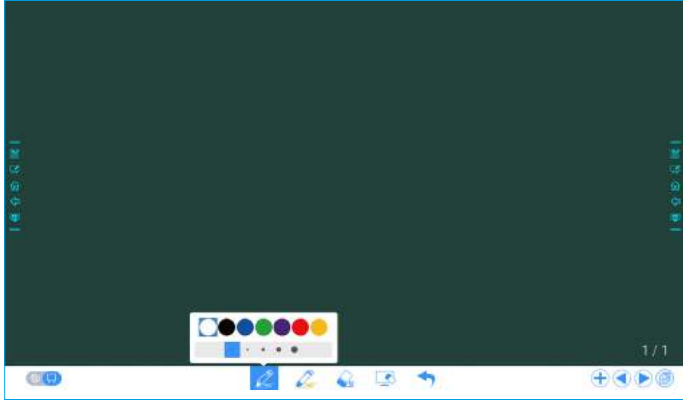

Eraser

Two methods are available to erase written errors or content as follows:

- Five-finger gesture: touch the screen with five fingers at the same time. A circle shows and indicates the area for eraser. Move the circle with fingers to erase written contents.
- Fist/hand back erasing: corresponding erase shape is a round with diameter 100pt.
- Spot erasing: Click  to clear wrong or unnecessary content. Click and hold the icon for two seconds to set the size of eraser (S 10pt/M 30pt/L 50pt), it would be shown by the icon, as shown in the following figure.



Screenshot

In annotation mode, click  to save the current image as a picture. Up to 50 screenshots can be created. Click and hold the icon for two seconds to show the pop-up windows to make users to choose if they want to save the screenshot automatically when they leave the annotation mode, as shown in following figure.

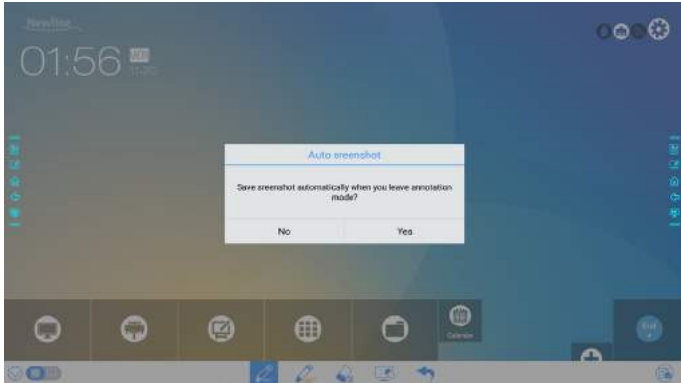

Pictures saved through screenshots can be viewed and obtained using the following methods:

- After a meeting is complete, screenshots are saved on the **Save meeting Discussion** page, as shown in the following figure.

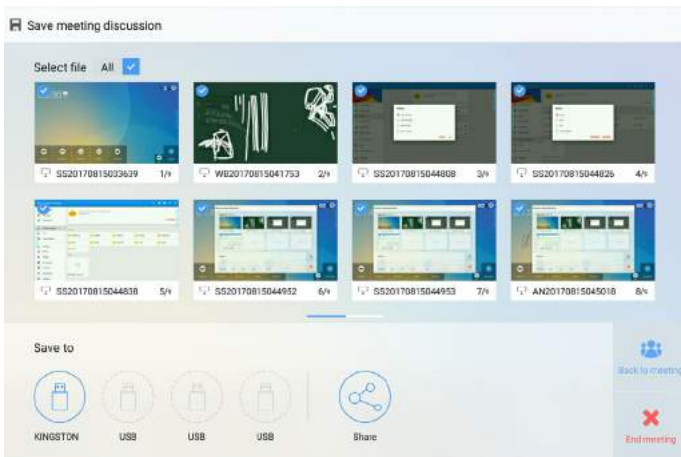

- Click  on the home page and choose **Internal storage > Pictures > Screenshots > image** to view or obtain screenshots.

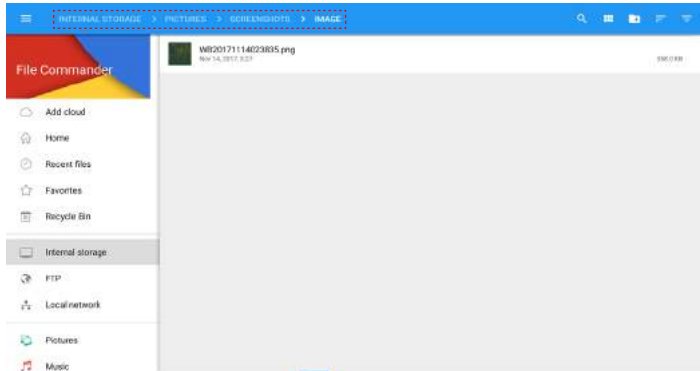

Clear All

On the Whiteboard page, click  to show the pop-up windows to make users to choose if they want to clear contents on current page, as shown in the following figure.

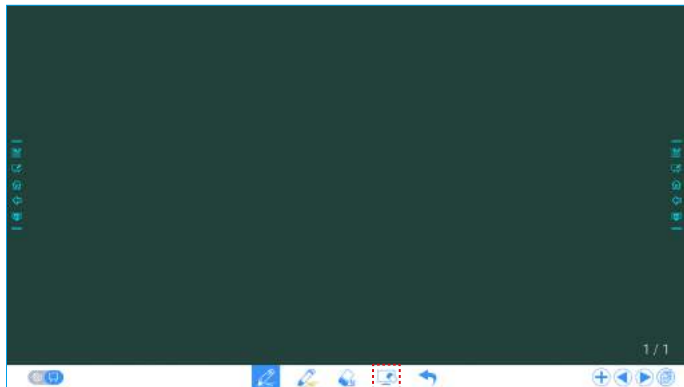

Page Operations

You can preview, select, and delete a created writing page.

Page Preview

Click  at the lower right corner in the discussion mode. All pages will be displayed. Click one page to switch to that page for more operations, as shown in the following figure.

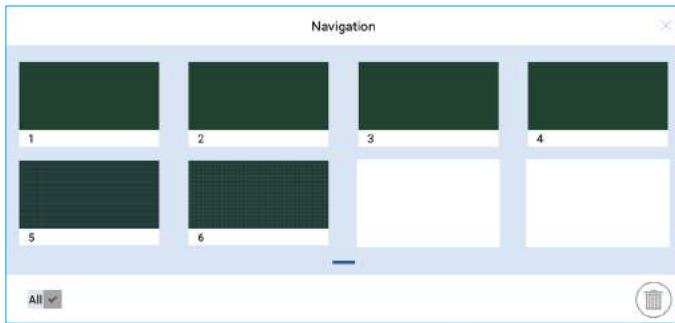

 Note

Only 8 pages are displayed at once, and you can slide right or left by one finger to see more.



Page Selection and Deletion

On the **Navigation** page, you can select or delete writing pages according to requirements, as shown in the following figure.

- Click  to select all pages.
- Click  to delete selected pages.

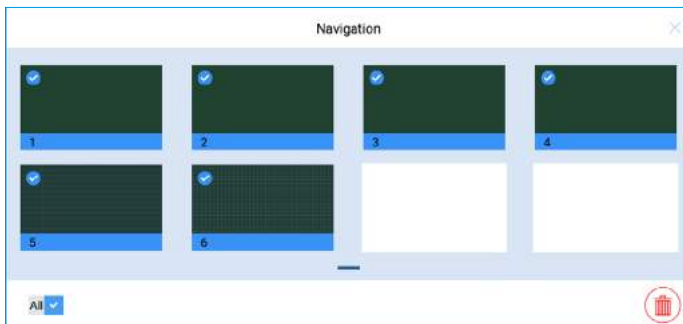



Add Shortcut

Add Shortcuts to Home Page

Step 1: On **Home** page, click the  icon in the lower right corner. The interface for adding shortcuts will be displayed.



Step 2: Click the icons on top to switch the list between Windows programs, external signal sources, and pre-installed gadgets.

- Click  to view the Windows programs that the Newline Assistant uploads to the Smart system. For details, see "Add Quick Start Windows Programs in Smart System".
- Click  to view signal sources in **Connection**. You can set the Newline accessories to signal sources at Newline Extensions setting.



- Click  to view Gadget applications.





Step 3: Add or delete applications on the tab.

- In the list, click the icon to add it to the shortcut on the **Home** page. The check icon will appear at the bottom of the shortcut icons. Up to 7 shortcuts can be added.
- Tap the icon with the check mark again, the check icon will disappear and the shortcut will be deleted from the **Home** page.



Step 4: At the **Home** page, click the shortcut icon and you can start the program/ application or change to the external signal source.

Add Quick Start Windows Programs in Smart System

Step 1: In Windows, run the **Newline Assistant** program and drag the software icons or folder shortcut icons that you want to add from desktop or menu to the **Newline Assistant** window. The applications added or deleted through the Windows system will be automatically updated to the smart system until the upload progress reaches 100%. If there is an application not updated, click  in the upper right corner to manually update all icons in the Newline assistant window to the smart system.

 **Tip:** Only .exe file and folder are supported.



Step 2: Click  to return to the **Home** page. Click the  icon and go to shortcut setting. The page for adding application program will be displayed.

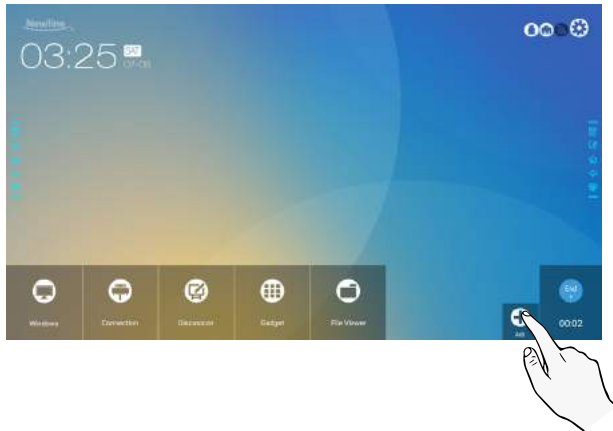

Step 3: At the shortcut setting page, click  icon to view all the Windows programs added by Newline Assistant in Step 1.



 **Note**

By default, the Newline Assistant application is added on the  tab.





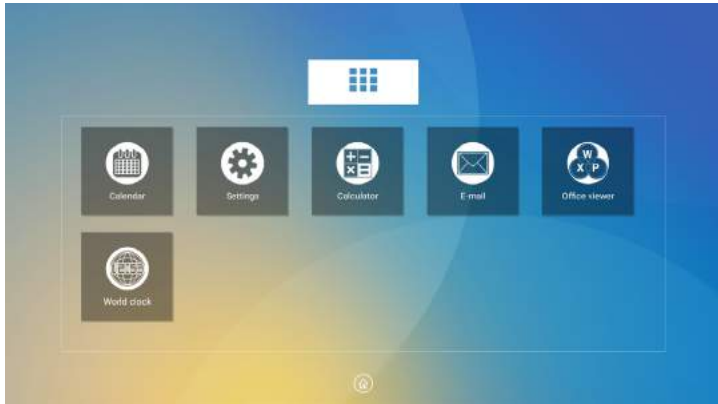

Step 4: Tap the icon and add the shortcut at the Home page. Tap again and remove it.

Step 5: Return to **Home** page. Click the icon of an added Windows software to start the software.

Gadget

On the **Home** page, click **Gadget**. On the page that is displayed, all applications can be viewed. The following figure shows applications that the system is delivered with.



Icon	Functions
	Click this icon to enter the Calendar application, set schedule, and update to Google Calendar.
	Click this icon to enter the system setting page.
	Click this icon to enter the calculator application.
	Click this icon to enter the email application and send files. Before sending files, you need to create an email account.
	Click this icon to enter the Office viewer application. In this application, you can view office files, including excel, word, power point, and PDF files.
	Click this icon to enter the World clock application. In this application, you can convert time and zone.

File Management

The product supports connection to USB flash memory. Enter the File Viewer application, you can preview all files in the internal storage and storage devices connected via USB ports and select, copy, paste, delete and search for files.

File Viewer Page

On the **Home** page, click **File Viewer**, as shown in the following figure.

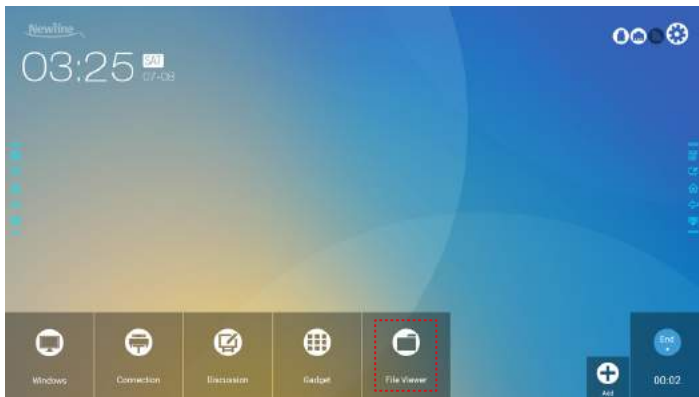

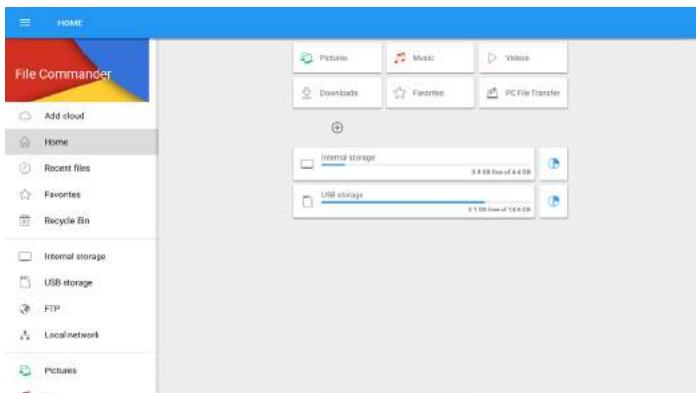

File Preview

Enter the **File Viewer** application, you can click the submenu at the left side according to requirements, preview internal storage, external storage devices connected via the USB ports, cloud stored files, FTP uploaded files, and local network files, as shown in the following figure.



File Filtering

You can click the menu at the left side to display files by types, for example, document, picture, music, video, archive and downloaded. You can also click  to filter files by picture, music and video.

- The system supports two view modes: list and thumbnail. You can click  and  at the top right corner to switch view modes, as shown in the following figure.

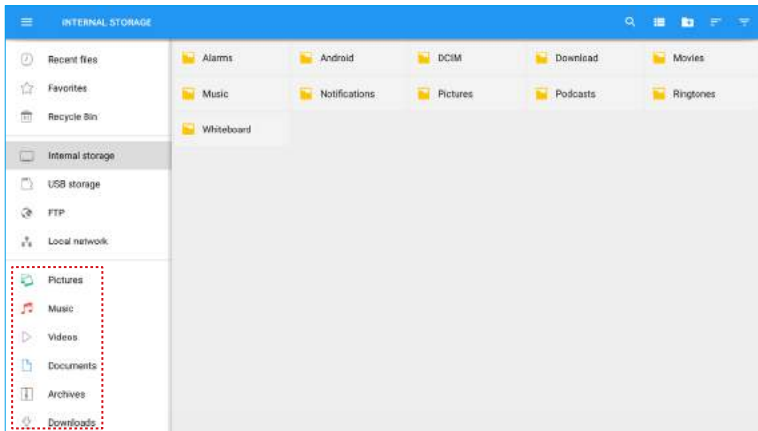

- Click  to display files based on name, type, size, and modification time in an increment or decrement manner.

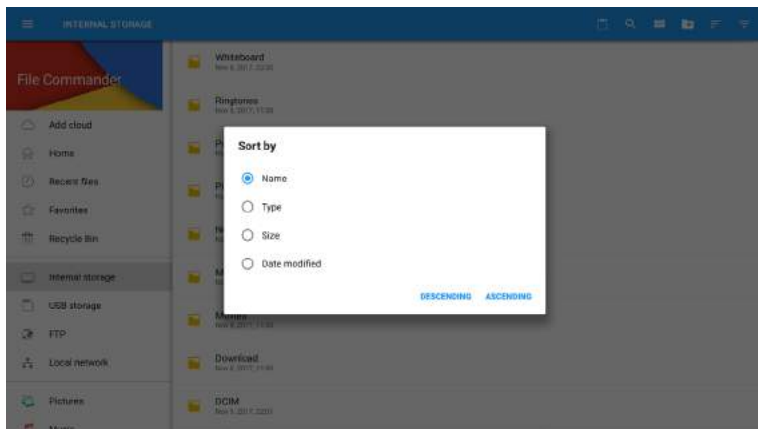

File Search

Enter the **File Viewer** application, and click . In the dialog box that is displayed, enter keywords in the search box according to requirements. The system will display a list of files that match the keywords.

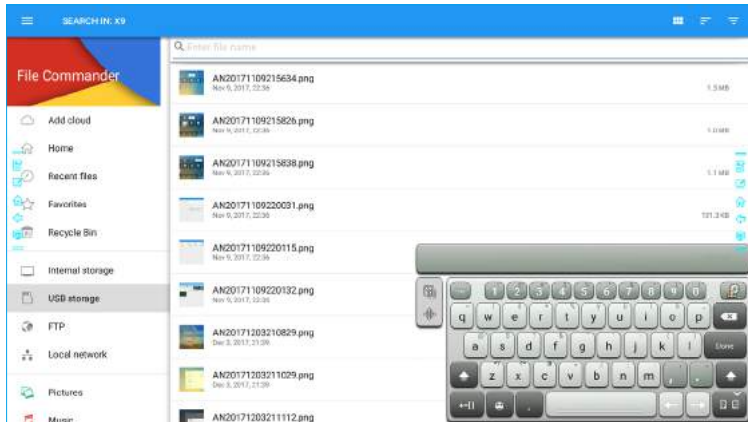

File Operation

Enter the **File Viewer** application. You can create folders according to requirements, select files by long pressing, and set wallpaper/copy/paste/delete. For details on other operation, click  in the upper right corner for more operation.

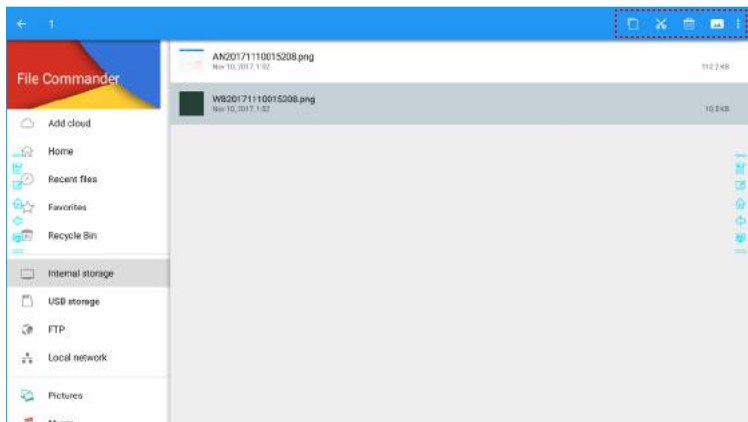

End Meeting

Manually End Meeting

On the **Home** page, click . The **Save meeting discussion** page will be displayed. The meeting will end and timer will stop.

File Name

The **Save meeting discussion** page displays pages, annotation page screenshots, and remote control screenshots in the discussion mode in this meeting, as shown in the following figure.

Picture files are named in the following of prefix + creation file. Slide left/right using a finger to switch pictures.

Prefix name rule: WB (discussion mode page), AN (annotation page screenshot), and SS (remote control screenshot).

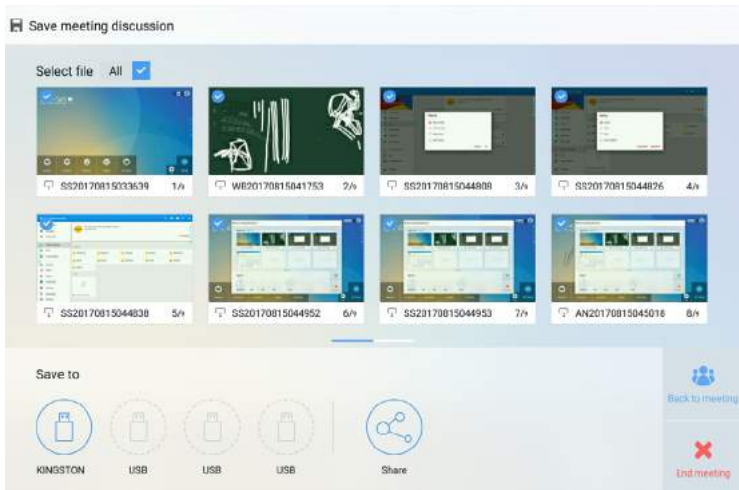

Save Meeting Data

When no external USB flash memories are connected, icons in the **Save to** area will be gray. When an external USB flash memory is connected, icons in the **Save to** area will turn into blue. Click the USB icon in blue. The “uc” folder will be created under the root folder, and the selected files will be saved in it.

- **Back to meeting:** The meeting will be continued; files are not cleared and timer continued.
- **End meeting:** The **Warning** dialog box will be displayed.
- Click **Confirm**. All writing pages and screenshots will be deleted, and go back to start screen page. The current meeting will be ended and the timer will reset.
- Click **Cancel**. The meeting continues and the system stays on the **Save meeting discussion** page.

 **Note**

- Do not eject USB flash memory before completing the saving process.
- If the USB flash memory is bigger than 16GB or the file format is not FAT32, the data will not be saved properly.

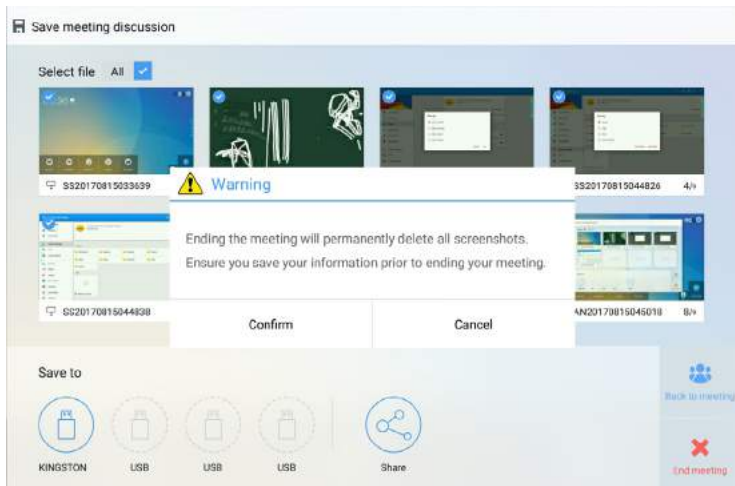

Send E-mail

Click the  button on the **Save meeting discussion** page, and click **AquaMail** to share current meeting files by email. Before sending, confirm that an email account is successfully set.

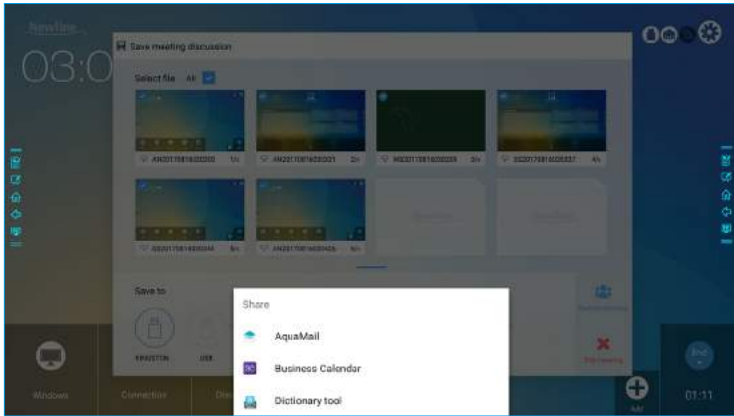

Automatically End Meeting

If the display is left un-operated for a specified duration, it will be locked to guarantee your privacy. Choose **Settings > Power ON/OFF** Setting to set the duration. For details on the setting method, see "Power ON/OFF Setting".

After the display is locked, if it is operated again within 120 seconds, the display is unlocked. Otherwise, the display enters the shut down mode and automatically deletes all meeting content. After the display is unlocked, the countdown dialog box will not appear in current meeting. The dialog box can be restored if you create a new meeting after current meeting is complete.

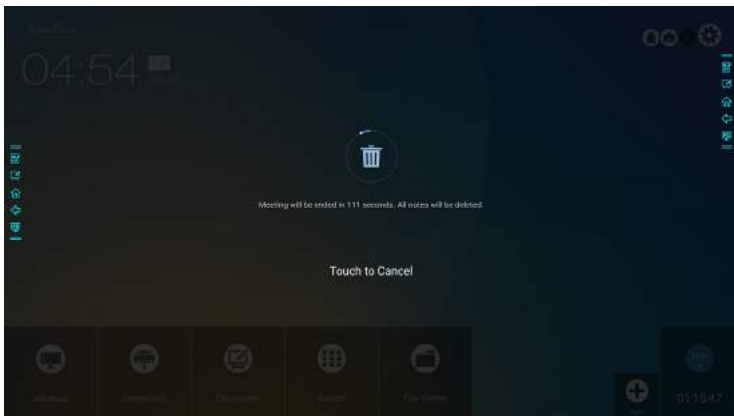

E

Quick Setting Menu

Using two fingers to swipe up from the bottom of the screen, the quick setting menu will then show up, as shown in the following figure.



Icon	Functions
	Drag the slider to adjust the brightness.
	Drag the slider to adjust the volume.
	Click the icon to mute/unmute.
	Click the icon to turn on/off the beep sound.
	Click the icon to turn on/off the blue light filter.
	Click the icon to turn on/off the Smart system Wi-Fi.
	Click the icon to turn on/off the audio only function.
	Click the icon to turn on/off the left toolbar.
	Click the icon to turn on/off the right toolbar.
	Click the icon to enter the settings page.
	Click the icon to return to Home page.

F

Serial Port Control

Connect RS-232 port to the PC or controlling product. Enable RS-232 serial port connection and complete the following configuration.

Port: COM1 (Set according to PC or controlling product's port number)			
Baud rate	19200	Odd/even check	None
Data bits	8	Stop bit	1

The following tables list controlling codes, querying codes and return.

Function	Controlling codes	Return codes
Power on	7F 08 99 A2 B3 C4 02 FF 01 00 CF	7F 09 99 A2 B3 C4 02 FF 01 00 01 CF
Power off	7F 08 99 A2 B3 C4 02 FF 01 01 CF	7F 09 99 A2 B3 C4 02 FF 01 01 01 CF
Mute/Unmute	7F 08 99 A2 B3 C4 02 FF 01 02 CF	7F 09 99 A2 B3 C4 02 FF 01 02 01 CF
Display status	7F 08 99 A2 B3 C4 02 FF 01 09 CF	7F 09 99 A2 B3 C4 02 FF 01 09 01 CF
HDMI front	7F 08 99 A2 B3 C4 02 FF 01 0A CF	7F 09 99 A2 B3 C4 02 FF 01 0A 01 CF
HDMI rear 1	7F 08 99 A2 B3 C4 02 FF 01 52 CF	7F 09 99 A2 B3 C4 02 FF 01 52 01 CF
HDMI rear 2	7F 08 99 A2 B3 C4 02 FF 01 53 CF	7F 09 99 A2 B3 C4 02 FF 01 53 01 CF
HDMI rear 3	7F 08 99 A2 B3 C4 02 FF 01 54 CF	7F 09 99 A2 B3 C4 02 FF 01 54 01 CF
Internal PC	7F 08 99 A2 B3 C4 02 FF 01 38 CF	7F 09 99 A2 B3 C4 02 FF 01 38 01 CF
DP	7F 08 99 A2 B3 C4 02 FF 01 56 CF	7F 09 99 A2 B3 C4 02 FF 01 56 01 CF
Page up	7F 08 99 A2 B3 C4 02 FF 01 13 CF	7F 09 99 A2 B3 C4 02 FF 01 13 01 CF
Page down	7F 08 99 A2 B3 C4 02 FF 01 14 CF	7F 09 99 A2 B3 C4 02 FF 01 14 01 CF

Function	Controlling codes	Return codes
VOL -	7F 08 99 A2 B3 C4 02 FF 01 17 CF	7F 09 99 A2 B3 C4 02 FF 01 17 01 CF
VOL +	7F 08 99 A2 B3 C4 02 FF 01 18 CF	7F 09 99 A2 B3 C4 02 FF 01 18 01 CF
Menu	7F 08 99 A2 B3 C4 02 FF 01 1B CF	7F 09 99 A2 B3 C4 02 FF 01 1B 01 CF
Home page	7F 08 99 A2 B3 C4 02 FF 01 1C CF	7F 09 99 A2 B3 C4 02 FF 01 1C 01 CF
Return (exit)	7F 08 99 A2 B3 C4 02 FF 01 1D CF	7F 09 99 A2 B3 C4 02 FF 01 1D 01 CF
OK	7F 08 99 A2 B3 C4 02 FF 01 2B CF	7F 09 99 A2 B3 C4 02 FF 01 2B 01 CF
←	7F 08 99 A2 B3 C4 02 FF 01 2C CF	7F 09 99 A2 B3 C4 02 FF 01 2C 01 CF
→	7F 08 99 A2 B3 C4 02 FF 01 2D CF	7F 09 99 A2 B3 C4 02 FF 01 2D 01 CF
↑	7F 08 99 A2 B3 C4 02 FF 01 2E CF	7F 09 99 A2 B3 C4 02 FF 01 2E 01 CF
↓	7F 08 99 A2 B3 C4 02 FF 01 2F CF	7F 09 99 A2 B3 C4 02 FF 01 2F 01 CF
Query the firmware version number	7F 08 99 A2 B3 C4 02 FF 01 3D CF	7F 09 99 A2 B3 C4 02 FF 01 3D 01 CF
Enable the comment function	7F 08 99 A2 B3 C4 02 FF 01 40 CF	7F 09 99 A2 B3 C4 02 FF 01 40 01 CF
Set volume	7F 08 99 A2 B3 C4 02 FF 05 XX CF NOTE: XX indicates the volume value (0 to 100), corresponding to hexadecimals 00 to 64.	7F 09 99 A2 B3 C4 02 FF 05 XX 01 CF
Set display mode	7F 08 99 A2 B3 C4 02 FF 06 XX CF NOTE: • XX = 00 indicates the Standard mode. • XX = 01 indicates the EnergyStar mode. • XX = 02 indicates the Auto mode.	7F 09 99 A2 B3 C4 02 FF 06 XX 01 CF

Function	Controlling codes	Return codes
Increase backlight brightness	7F 08 99 A2 B3 C4 02 FF 01 47 CF	7F 09 99 A2 B3 C4 02 FF 01 47 01 CF
Decrease backlight brightness	7F 08 99 A2 B3 C4 02 FF 01 48 CF	7F 09 99 A2 B3 C4 02 FF 01 48 01 CF
Set the value of backlight brightness	7F 08 99 A2 B3 C4 02 FF 09 XX CF NOTE: XX indicates the value of backlight brightness (0 - 100), corresponding to the hexadecimal number system (00 - 64).	7F 09 99 A2 B3 C4 02 FF 09 XX 01 CF
Switch backlight	7F 08 99 A2 B3 C4 02 FF 01 15 CF	7F 09 99 A2 B3 C4 02 FF 01 15 XX CF NOTE: ● XX = 01 indicates the backlight is on. ● XX = 00 indicates the backlight is off.
Switch to child safety lock	7F 08 99 A2 B3 C4 02 FF 01 57 CF	7F 09 99 A2 B3 C4 02 FF 01 57 01 CF
Screenshot	7F 08 99 A2 B3 C4 02 FF 01 1F CF	7F 09 99 A2 B3 C4 02 FF 01 1F 01 CF
Settings	7F 08 99 A2 B3 C4 02 FF 01 20 CF	7F 09 99 A2 B3 C4 02 FF 01 20 01 CF

Function	Querying codes	Return codes
Power supply	7F 08 99 A2 B3 C4 02 FF 01 37 CF	7F 09 99 A2 B3 C4 02 FF 01 37 XX CF NOTE: XX indicates the power on/off state. <ul style="list-style-type: none"> ● XX = 01: power on state ● XX = 00: power off state
Speaker	7F 08 99 A2 B3 C4 02 FF 01 82 CF	7F 08 99 A2 B3 C4 02 FF 01 82 XX CF NOTE: <ul style="list-style-type: none"> ● 01: mute ● 00: non-mute
Current signal source	7F 08 99 A2 B3 C4 02 FF 01 50 CF	7F 09 99 A2 B3 C4 02 FF 01 50 XX CF NOTE: <ul style="list-style-type: none"> ● Smart system = 30 ● PC = 17 ● DP = 20 ● HDMI rear 1 = 1F ● HDMI Rear 2 = 1E ● HDMI Rear 3 = 18 ● HDMI Front = 19
Speaker volume	7F 08 99 A2 B3 C4 02 FF 01 33 CF	7F 09 99 A2 B3 C4 02 FF 01 33 XX CF NOTE: XX indicates current volume value (XX is a hexadecimal value, range: 00~64). For example, XX = 20 indicates current volume value is 32 (decimal value), XX = 00 indicates mute state.
D.Mode	7F 08 99 A2 B3 C4 02 FF 01 35 CF	7F 09 99 A2 B3 C4 02 FF 01 35 XX CF NOTE: XX indicates the mode. 00 and 01 indicate standard and eco modes respectively.
Backlight brightness	7F 08 99 A2 B3 C4 02 FF 01 49 CF	7F 09 99 A2 B3 C4 02 FF 01 49 XX CF NOTE: XX indicates the value of backlight brightness (0 - 100), corresponding to the hexadecimal number system (00 - 64).
Backlight status	7F 08 99 A2 B3 C4 02 FF 01 81 CF	7F 08 99 A2 B3 C4 02 FF 01 81 XX CF NOTE: <ul style="list-style-type: none"> ● XX = 00 indicates the backlight is on. ● XX = 01 indicates the backlight is off.

Function	Querying codes	Return codes
Switch to child safety lock	7F 08 99 A2 B3 C4 02 FF 01 84 CF	7F 08 99 A2 B3 C4 02 FF 01 84 XX CF NOTE: <ul style="list-style-type: none"> • XX = 01 indicates the child safety lock is on. • XX = 00 indicates the child safety lock is off.
Whiteboard state	7F 08 99 A2 B3 C4 02 FF 01 83 CF	7F 08 99 A2 B3 C4 02 FF 01 83 XX CF NOTE: <ul style="list-style-type: none"> • XX = 01 indicates the whiteboard state. • XX = 00 indicates non-whiteboard state.
Return to system state of the previous 9 options	7F 08 99 A2 B3 C4 02 FF 0A 00 CF	7F 08 99 A2 B3 C4 02 FF 0A 00 AB CD EF GH IJ OP QR ST UV CF NOTE: <ul style="list-style-type: none"> • AB: Power supply • CD: Speaker • EF: Current signal source • GH: Speaker volume • IJ: D.Mode • OP: backlight brightness • QR: backlight state • ST: Whiteboard state • UV: Switch to child safety lock

G

FAQs & Troubleshooting

Symptom	Troubleshooting Methods
The screen cannot be powered on or the indicator is off.	Check whether the power supply is connected.
	Check whether the power supply plug is properly connected.
	Check whether the power supply line is properly connected.
	Check whether the rocker switch is enabled.
	Press the reset switch and start the system again.
The remote control is not causing a response.	Replace the batteries.
	Check whether the polarity direction of the batteries is correct.
	Use the remote control aligning with the IR receive window. For details, see section "Remote Control".
The image is normal but there is no sound.	Increase volume on both the display and the Windows system.
	Check whether the display and the Windows system are muted.
	If an external computer is connected, check whether the connection cables are normal.
During the video conference, the remote party cannot hear the sound of the local party.	In Control Panel > Sound , set the product parameters to the default values in the Recording tab page.

Symptom	Troubleshooting Methods
The system is automatically powered on/off when no operation is performed.	Disable the automatic power-on/off function. For details, see section "Power ON/OFF Setting".
	Check whether the display entered shut down mode due to no operation for an extended period of time.
	Check whether the input power supply is stable.
The colors of images are abnormal.	Check whether the HDMI cable is properly connected or has any quality issue.
The touch function is abnormal or the positioning is inaccurate.	Restart the display.
	In the Windows system, perform positioning again. For details, see section "Positioning".
The touch function is unavailable when the external signal source channel is being used.	Switch between different external signal sources.
	Ensure that the USB touch cable is connected to the proper port. For details, see section "Ports".
	Remove and insert the USB touch cable again.
There is no sound when the HDMI in channel is used.	Remove and insert the HDMI cable again.
No image is displayed when the HDMI out channel is used.	Generally, this issue is caused by the compatibility of the external display product. Replace the external display product and test again.
	The HDMI cable is too long or has a poor quality. Replace the HDMI cable delivered with the product.
The touch function on the front panel is ineffective.	Touch the button using the fingertip completely.
	Check whether the finger is wet or has other liquids on it.
	Restart the display.
The USB flash memory cannot be identified.	Check whether the USB flash drive is inserted into the correct USB port. For details, see section "Ports".

Symptom	Troubleshooting Methods
The conference records cannot be saved on the USB flash drive, and the system prompts "The target storage product has no write permissions."	Format the USB flash drive to the FAT32 format.
The internal PC has no signal.	Check whether the internal PC is properly inserted in the slot.
	Check whether the internal PC enters the shut down state.
	Press the power button on the internal PC (for details, see the instructions of the internal PC), and manually start up the internal PC.
In the Smart system or Windows system, no wireless network can be found or the wireless network signal is weak.	Check whether the Wi-Fi antenna is properly installed on the Smart system. For details, see section "Ports".
	Check whether the Wi-Fi antenna is properly installed for the internal PC.
The keyboard is not correctly displayed.	Confirm that the hardware keyboard is enabled.



Specifications

Model	TT-6518VN	TT-7518VN	TT-8618VN
Display			
Backlight	LED		
Display Area	1431.50 mm x 806.50 mm	1653.24 mm x 931.26 mm	1895.04 mm x 1065.96 mm
Active Screen Size	65 inch	75 inch	85.60 inch
Display Ratio	16:9		
Resolution	3840 horiz. by 2160 vert. Pixels, RGB stripe arrangement		
Display Colors	10 bit, 1.07 billion colors		
Brightness	350 nit		
Contrast	1300:1		
Response Time	8 ms		
Life Time	50000 h (Min.)		
Speaker			
Speaker Position	Forward		
Max. Power Output	2 x 15 W		
Electrical			
Power Consumption	Maximum \leq 220 W Standby Mode \leq 0.5 W	Maximum \leq 300 W Standby Mode \leq 0.5 W	Maximum \leq 450 W Standby Mode \leq 0.5 W
Working Voltage	AC 100 V – 240 V, 50 Hz/ 60 Hz		
Touch			
Touch Surface	Anti-glare tempered glass		
Transparency	88%		
Surface Hardness	7 H		
HID support	HID		

Model	TT-6518VN	TT-7518VN	TT-8618VN
Touch Points	10 Points		
Writing Tools	Eraser, Stylus or Finger		
Scan Speed	250 Hz		
Positioning Accuracy	Center area 1.0 – 1.5 mm/ Edge area 1.2 – 2.0 mm		
Communication Interface	USB-A		
Transportation/Storage			
Storage Temperature/ Humidity	-20 °C – 60 °C/20% RH – 80% RH(Non coagulation)		
Working Temperature/ Humidity	0 °C – 40 °C/20% RH – 80% RH(Non coagulation)		
Mounting (optional)	Wall-mounted/ Floor Stand		
Outline Dimension	1546 mm x 944 mm x 89 mm	1771 mm x 1071 mm x 104 mm	2018 mm x 1211 mm x 104 mm
Packing Dimension	1720 mm x 1085 mm x 275 mm	1918 mm x 1190 mm x 275 mm	2155 mm x 1320 mm x 310 mm
Net Weight	39.5 kg	50.5 kg	65.0 kg
Gross Weight	55 kg	68 kg	87 kg
Ports			
Front Interface Inputs	HDMI In x 1, USB (Touch) x 1, USB (Public) x 2		
Rear Interface Inputs	HDMI In x 3, DP x 1, USB (Touch) x 4, HDMI Out x 1, DC Out (5 V, 2 A), SPDIF out x 1, Earphone out x 1, USB 2.0 (Public) x 1, USB 2.0 (Embedded) x 1, RS-232 x 1, RJ45 x 2, USB 3.0 (Public) x 1, OPS Slots (4 K@60 Hz), Line Out x 1		
Other functions			
Intelligent thermos protector	Yes		
Build-in WIFI	2.4 G/ 5 G (Optional)		

Model	TT-6518VN	TT-7518VN	TT-8618VN
Smart System			
Chips	ARM A53 x 41.4 GHz		
RAM	2 GB		
Flash	8 GB		
Multimedia File Formats	Supports all major types of multi-media files		
Android Software			
On Screen Annotation	Yes		
Discussion Board	Yes		



More Information

For more information

Please visit our website (www.newline-interactive.com) for detailed instruction manual.

Contact Us for Support

Please email us at support@newline-interactive.com.